

## Structure of microfiche

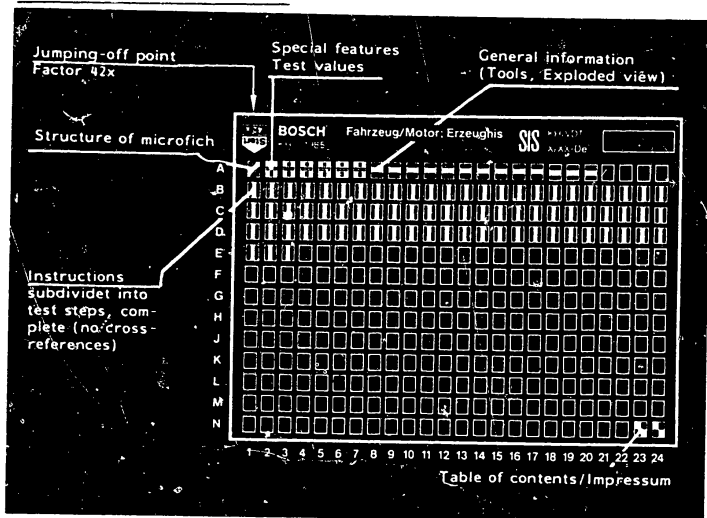

1. Read from left to right
2. Title of microfiche (appears on each coordinate)

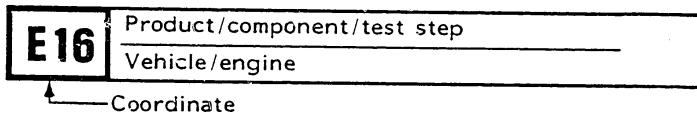

3. Limits of section

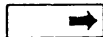

Beginning

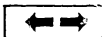

Mid-section

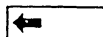

End

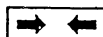

One-page section

4. Purely vehicle-specific passages in the text are marked with a vertical bar.

5. Reference to relevant working steps in the test specifications, e.g. coordinate C6.

**C6**

**A1**

## 1. Special Features

Repair instructions for in-line injection pumps of series PE (S)..A...C / A..D/S 1000/S 2000/S 3000 without governor, manifold-pressure compensator and timing device.

The various models of governor are repaired according to the respective repair instructions.

## 2. Test Specifications

2.1 Projection of camshaft  
(between measuring rule and pump housing)

Specification: 9.3 ... 10.3 mm

Special version      Specification: 13.3 ... 14.3 mm

---

**D20**

2.2 Axial play of camshaft

Setting tolerance      Checking tolerance

Deep-groove ball bearing      0.03 ... 0.13 mm      0.01 ... 0.15 mm

Tapered-roller bearing      0.02 ... 0.06 mm      0.01 ... 0.07 mm

---

**D21**

2.3 Sealing dimension for delivery valve  
with double seal

Specification:      18.4 ... 18.6 mm

**G21**

**A2**

Special Features/Test Specifications

PE(S)..A, 0 410 ..



#### 2.4 Leak test (suction gallery)

Test duration and test pressure  
4 minutes at 5 bar

---

**D2**

#### 2.5 Leak test (camshaft chamber etc.)

Test duration and test pressure  
3 minutes at 1.5 bar, then  
1 minute at 0.5 bar

---

**E3**

#### 2.6 Tightening torques

Screws, nuts etc. are itemized on a drawing on the following Coordinates A4/A5. These items are repeated on Coordinates A6/A7 with the corresponding tightening torque.

---

**A3**

Test Specifications  
PE(S)..A..., 0 410 ..



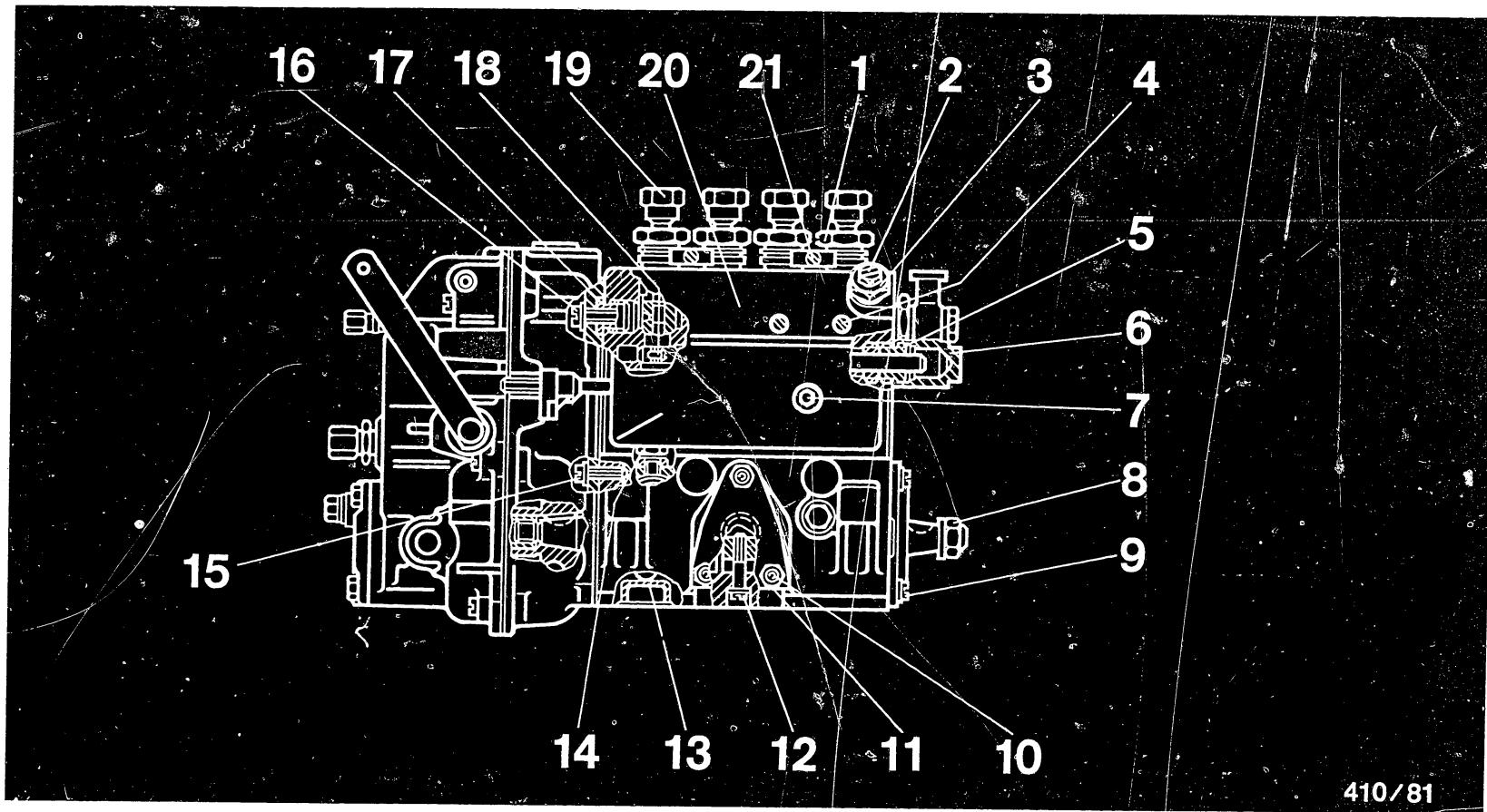

410/81

Item	Coordinates
1 ... 9	A 6
10 ... 21	A 7

**A4**

Test Specifications  
PE(S) ..A.., 0 410 ..



**A5**

Test Specifications  
PE(S) ..A.., 0 410 ..



## Tightening torques

Item No.	Description	Nm
1	Delivery-valve holder without id. groove (PE(S)..A..C)	45-0-45-0-45...50
	with id. groove (PE(S) 2...6 A.. D.. )	40-0-40-0-40...50
	with id. groove (PE(S) 8...12A.. D.. )	30-0-30-0-33...37
	with nylon seal rings (PE(S)..A..C..)	45 ... 50
2	Bleeder screw M6	4 ... 5
3	Threaded bushing	20 ... 30
4	Baffle screws M6	7 ... 9
	Baffle screws (micro- encapsulated) M8	15 ... 20
5	Control-rod guide bushing, 1-part	40 ... 60
	2-part	Checking torque 30 15 ... 20
6	Closure cap	10
7	Spring-chamber cover screws M6	4 ... 5
8	Timing device/coupling	

Model	Cone dia.	Thread	Nm
PE(S)..A..	17 mm	M 12	60 ... 70
	20 mm	M 14 x 1.5	80 ... 90
PES4A..Ford	20 mm	M 14 x 1.5	60 ... 70
PES6A..			
PE8A.. MAN	25 mm	M 18 x 1.5	100 ... 110
PE10A..			

9	Bearing end plate	
	fastening screws M6	7 ... 9
	M8	11 ... 16

**A6**

Test Specifications

PE(S)..A.., 0 410 ..



## Tightening torques (continued)

Item No.	Description	Nm
10	Threaded pin	3 ... 4
11	Hexagon nut	7 ... 10
12	Fillister-head screw for intermediate bearing	3.5 ... 5.5
13	Base screw plugs	55 ... 75
14	Roller-tappet hexagon nut	15 ... 25
15	Governor fastening screws M6	6 ... 8
16	Governor fastening screw - flat-head screw M8	13 ... 18
	Governor fastening screw - hexagon screw M8	18 ... 20
	Governor fastening screw - fillister head screw M8	15 ... 18
17	Screw plug M18 x 1.5	60 ... 70
18	Clamping screw on ring gear M 4.5	3 ... 4
19	Union nut (with fuel-injection tubing) M12 x 1.5	max. 25
20	Control-rod locating screw M6	5 ... 6
21	Fillister-head screw	5 ... 6.5

**A7**Test Specifications  
PE(S)..A.., 0 410 ..

### 3. General Information

- Camshaft bearings, worn or damaged components as well as sealing elements must always be replaced.
- Injection-pump components, which are stored for a lengthy period of time, must be covered and protected against corrosion.

#### 3.1 Lubrication instructions

Radial-lip type oil seal	Lightly oil with lubricating oil 5 962 260 605
Plunger-and-barrel Assys. and delivery valves	Wash in cleaning agent; wet plungers with calibrating oil.
O-rings	
Double-lip seal ring	Rub with tallow (commercially available). Pack space between sealing lips with high-temperature bearing grease 5 700 002 025.

#### 3.2 Cleaning the components

Wash components in low-inflammability, commercially available cleaning agent, e.g. Chlorothene NU. Then blow out with compressed air.

3.3 To prevent possible skin rashes when immersing in the calibrating oil, grease hands with protective skin cream prior to the leak test on the suction gallery and the camshaft chamber, and wash with soap and water after testing.



### 3.4 Safety regulations for the handling of combustible liquids

Decree On Working With Combustible Liquids (Vbf) issued by the Federal Ministry of Labor (BmA).

Safety Rules for Handling Chlorinated Hydrocarbons

for the Workshop                   ZH 1/222

for the Employee                   ZH 1/119

issued by the Central Association of German Employers' Liability Insurance Associations (Central Association for Accident Prevention and Industrial Medicine)

Langwartweg 103, 5300 Bonn 5.

In countries outside the Federal Republic of Germany, observe the corresponding local regulations.

**A9**

General Information

PE(S)..A..., 0 410 ..





#### 4. Tools, fixtures, lubricants

Description	Part No.	Use
Clamping support	KDEP 2919	Clamping the injection pump
Support clamp	KDEP 2963	For pumps with end-flange mounting
Clamping flange	1 685 720 017 1 685 720 014	For pumps with end-flange mounting
Reduction ring 72 mm diameter 80 mm diameter 85 mm diameter 76.2 mm diameter	1 680 103 007 1 680 202 004 1 680 202 005 1 680 202 017	For pumps with end-flange mounting
Coupling half 17 mm cone 20 mm cone 25 mm cone	1 416 430 012 1 416 430 017 1 416 430 022	Driving the injection pump
Clamping parts	KDEP 2919/2	For pumps with cradle mounting
Over-long shaft	KDEP 2919/1/13	10 and 12 cyl. injection pumps

**A10**

Tools, Fixtures, Lubricants  
PE(S)...A..., 0 410 ..



Tools, fixtures, lubricants (continued)

Description	Part No.	Use
Mounting sleeve 17 mm diameter 20 mm diameter 25 mm diameter	KDEP 2874 KDEP 2876 KDEP 2925	Mounting the bearing end plate
Tappet forceps	KDEP 2941	Removing and installing the roller tappets
Screwing device	KDEP 2993	For screw plugs at unused fuel inlet
Tappet holder	KDEP 2912	For fixing roller tappets in place
Valve lifter M12 x 1 M14 x 1	KDEP 2977 KDEP 2892	Removing delivery valve
Tappet holder	KDEP 2995	Fixing roller tappets in place on pumps of series S-3000

**A11**

Tools, Fixtures, Lubricants  
PE(S)..A.., 0 410 ..



Tools, fixtures, lubricants (continued)

Description	Part No.	Use
Screwing device	KDEP 2859 KDEP 2907	Screwing on and off control-rod stop/guide bushings
Puller	KDEP 2918 KDEP 2858	Pulling off the drive coupling
Holding wrench	KDEP 2906	Holding and turning the camshaft
Plunger pliers	KDEP 2915	Holding the plungers when removing and installing
Hand milling cutter dia. 11 x 14 mm dia. 13 x 16 mm dia. 14 x 18 mm	KDEP 2951 KDEP 2952 KDEP 2955	Smoothing the seats of plunger-and-barrel assys. in pump housing
Reamer	KDEP 2999	Reaming the control-rod guide bushings
Axial-play measuring device 17 mm diameter 20 mm diameter 25 mm diameter	KDEP 2890 KDEP 2927 KDEP 2967	Measuring the camshaft axial play



Tools, fixtures, lubricants (continued)

Description	Part No.	Use
Measuring rule	KDEP 2899	Measuring the camshaft projection
Screwdriver	KDEP 2873	Screwing in and out the control-rod guide bushings
Puller	KDEP 1056	Pulling off the control-rod guide bushings
Press-in mandrel	KDEP 1584	Pressing in the control-rod guide bushings
Support plate	KDEP 1581	Leak test on suction gallery
Forcing-off plate	KDEP 1580	Forcing off the camshaft bearings
Press-on sleeve 17/20 mm diameter 25/30 mm diameter	KDEP 1582 KDEP 1583	Pressing on the camshaft bearings

**A13**

Tools, Fixtures, Lubricants

PE(S)..A.., 0 410 ..



## Tools, fixtures, lubricants (continued)

Description	Part No.	Use
Knock-in and -out mandrel	KDEP 1585	Removing and installing the base plugs
Tool board	KDAW-T 100	Pulling off the ball-bearing outer races on bearing end plates

### 4.1 Lubricants

Special gear grease (Ft 1v27)	Tube 50g Tube 250g	5 700 052 005 5 700 052 025
Hylomar sealant (VS 9844-KK)	Tube 25g	5 927 350 002
Sealing paint, yellow (Kk 26v9)	Tube 30g	5 703 245 003
High-temperature bearing grease (Ft 1v4)	Tube 250g	5 700 002 025
Lubricating oil (VS 13834 0L)	0.5 l can	5 962 260 605



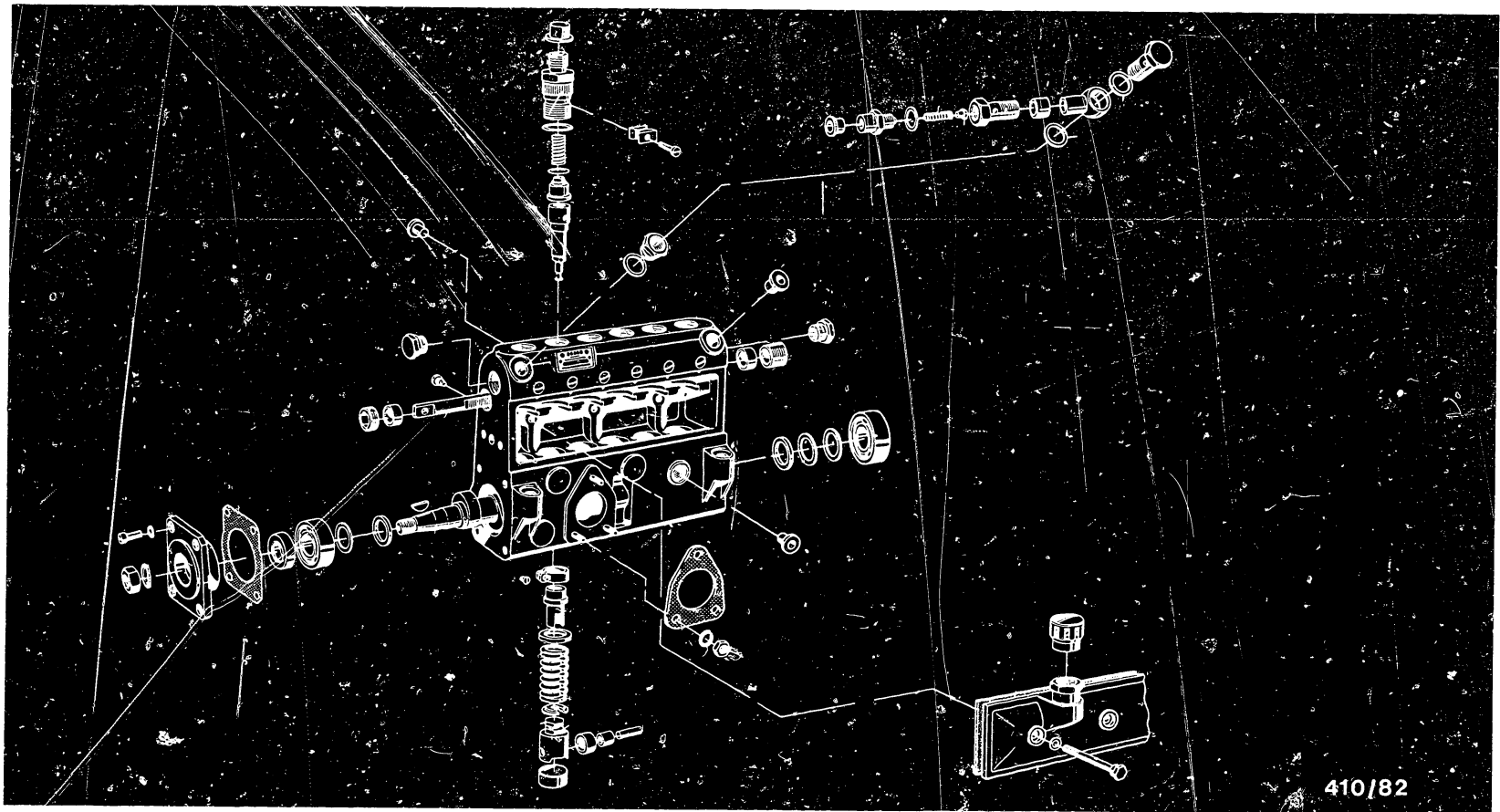

5. Exploded view of series PE(S).. S 1 000

Special features:

- deep-groove ball bearings
- no intermediate bearing

**A15**

Exploded view  
PE(S)..A.., 0 410 ..



**A16**

Exploded view  
PE(S)..A.., 0 410 ..



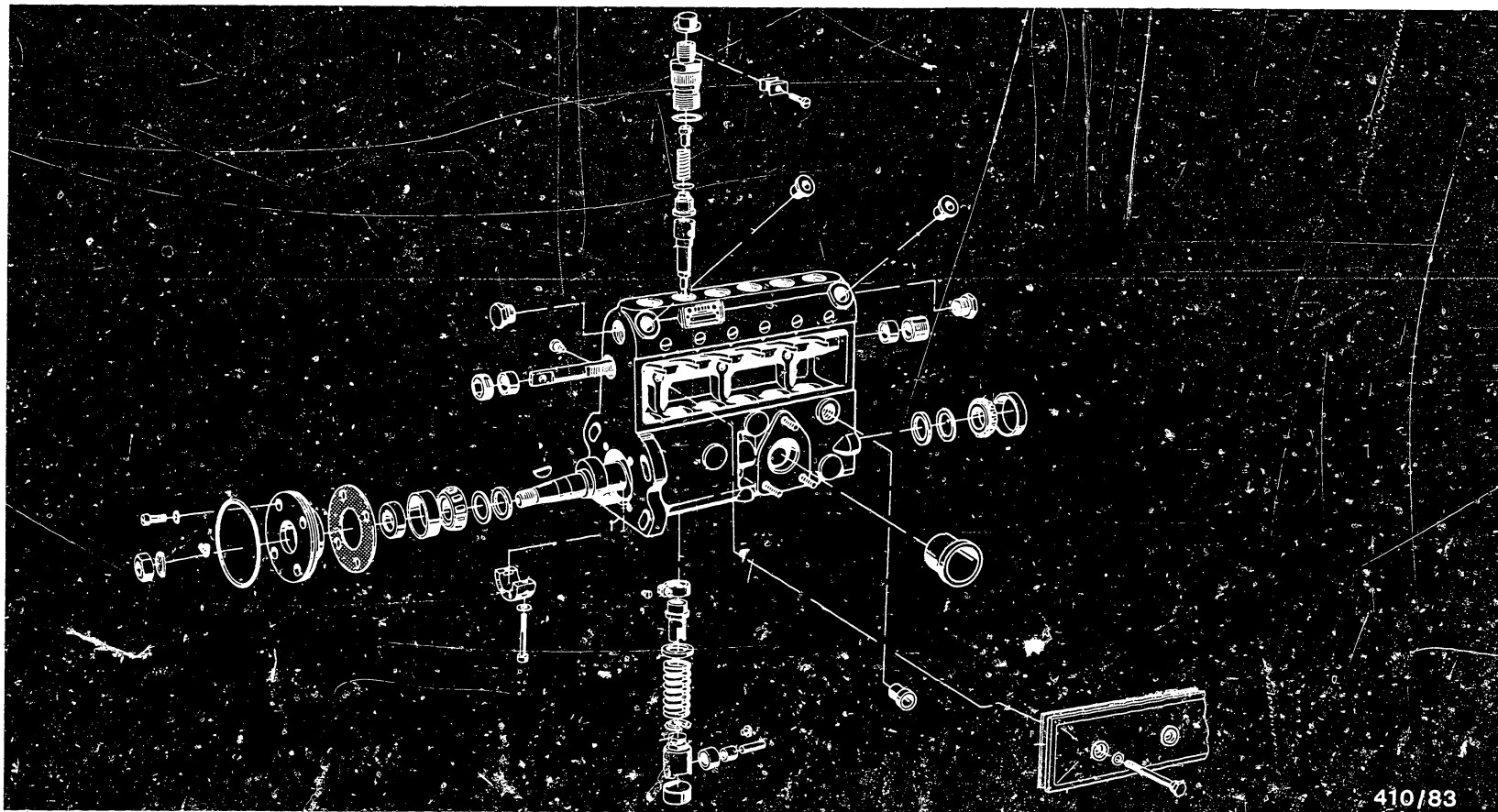

410/83

Exploded view of series PE(S) ... S 2 000

Special features:

- tapered-roller bearings
- intermediate bearing as of 6-cylinder injection pump

**A17**

Exploded view  
PE(S)..A..., 0 410



**A18**

Exploded view  
PE(S)..A..., 0 410 ..



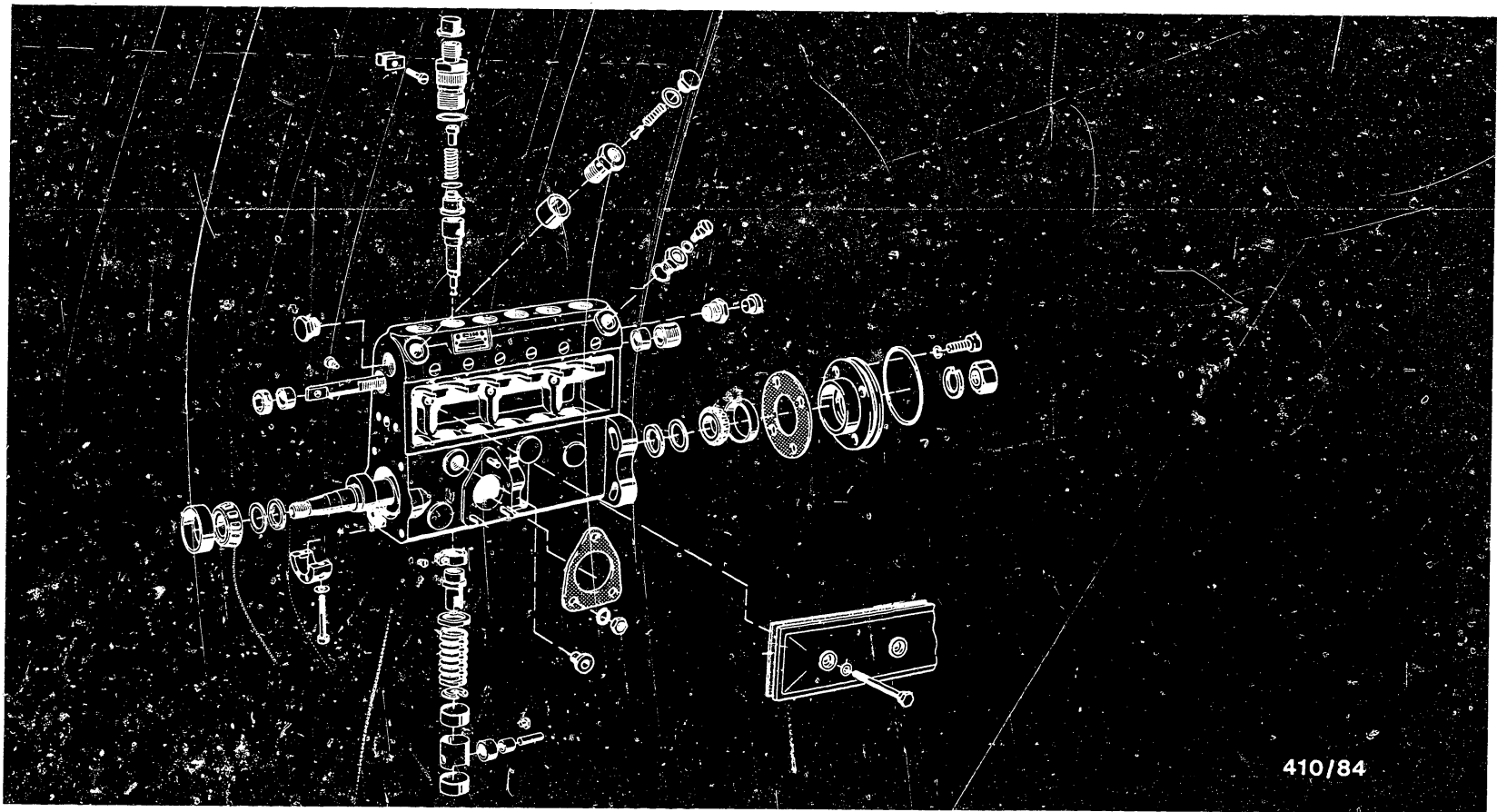

410/84

Exploded view of series PE(S)...S 3 000

Special features:

- tapered-roller bearings
- intermediate bearing
- prestroke adjustment by means of tappet plates

**A19**

Exploded view  
PE(S)..A.., 0 410 ..



**A20**

Exploded view  
PE(S)..A.., 0 410 ..





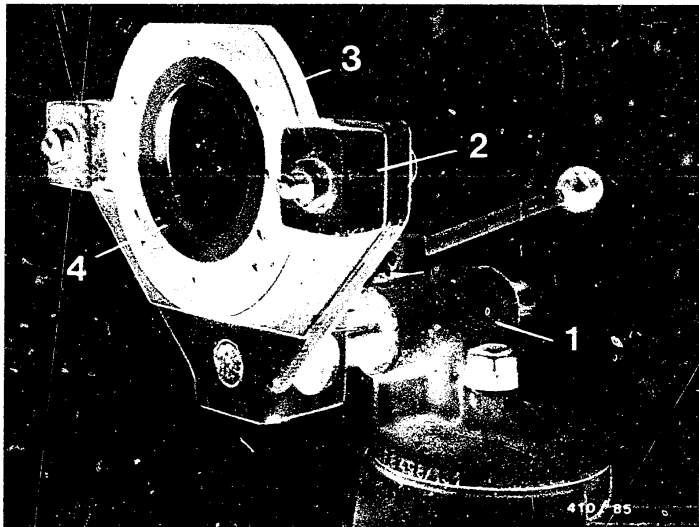

- 1 = Clamping support KDEP 2919
- 2 = Support clamp KDEP 2963
- 3 = Clamping flange to suit version of pump
- 4 = Reduction ring to suit pilot diameter

#### 6. Clamping the injection pump

The clamping fixtures shown in the picture are required for clamping injection pumps with end-flange mounting.

**B1**

Clamping the Injection Pump  
PE(S)..A.., 0 410 ..



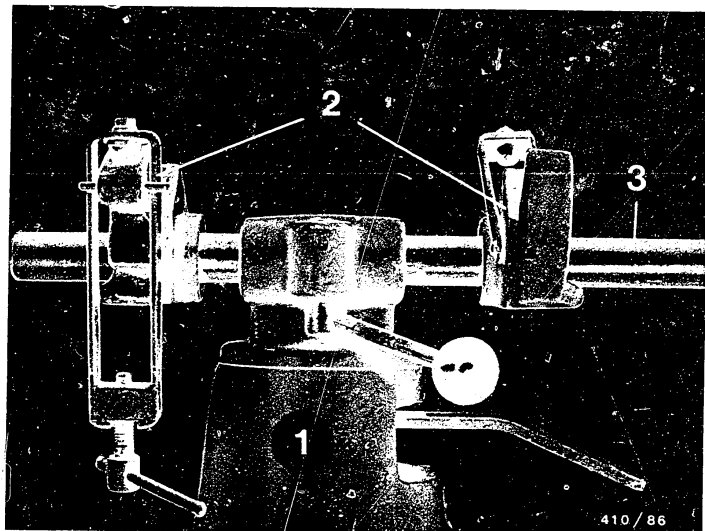

- 1 = Clamping support KDEP 2919
- 2 = Clamping parts KDEP 2919/2
- 3 = Over-long shaft KDEP 2919/1/13 for 10 and 12 cylinder injection pumps

The parts shown in the picture are required for injection pumps with cradle mounting.

**B2**

Clamping the Injection Pump  
PE(S)..A.., 0 410 ..



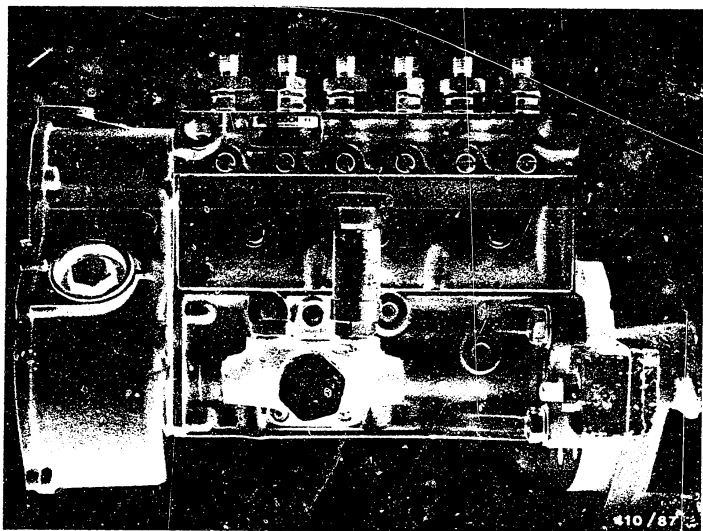

### 7. Dismantling the Injection Pump

- If mounted, remove drive components (multi-plate clutch, gear or timing device) using suitable commercially available tools.  
Exception: MAN engine D2530 MX; remove drive part with KDEP 1557.
- Mount drive coupling to suit cone diameter of camshaft and tighten.
- Dismantle governor in accordance with the respective repair instructions.

**B3**

Dismantling the Injection Pump  
PE(S)..A.., 0 410 ..



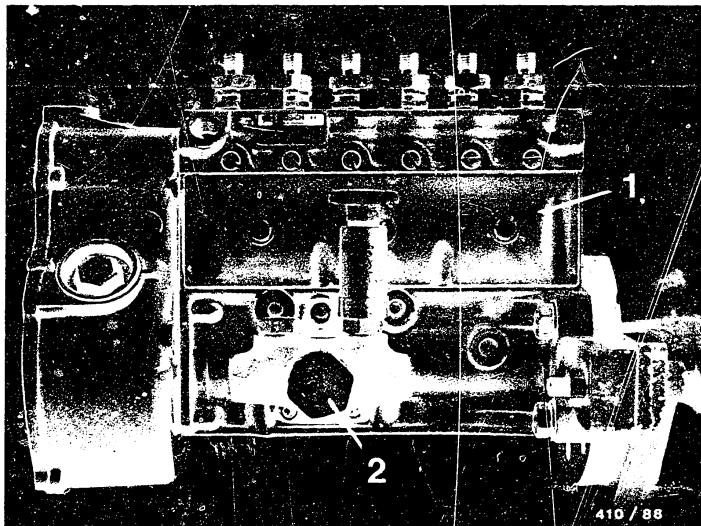

1 = Closing cover

2 = Supply pump

Remove closing cover and supply pump.

Note:

Arrange a suitable number of storage boxes as appropriate to the size of the injection pump to accept loose components.

**B4**

Dismantling the injection pump  
PE(S)..A.., 0 410 ..



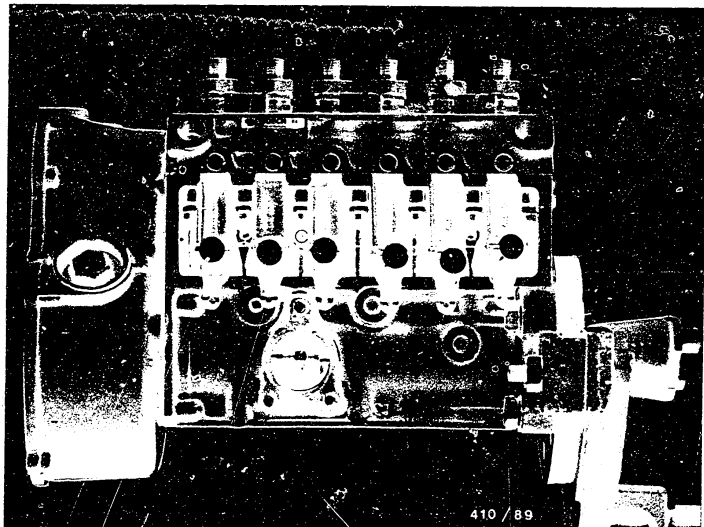

Series S-1000/2000

Turn camshaft with holding wrench KDEP 2906 and, with the respective cam at TDC, fix roller tappet in place with tappet holder KDEP 2912 (see picture).

Position tappet holder so that the lug of the holder comes between tappet screw and lock nut.

Press lever down; support locking pawl on upper closing cover pilot.

It must be possible for the camshaft to turn without touching the roller tappet.

Note:

Do not raise roller tappet with tappet holder (without supporting the cam). Lug of tappet holder may break off.

**B5**

Dismantling the Injection Pump  
PE(S)..A.., 0 410 ..



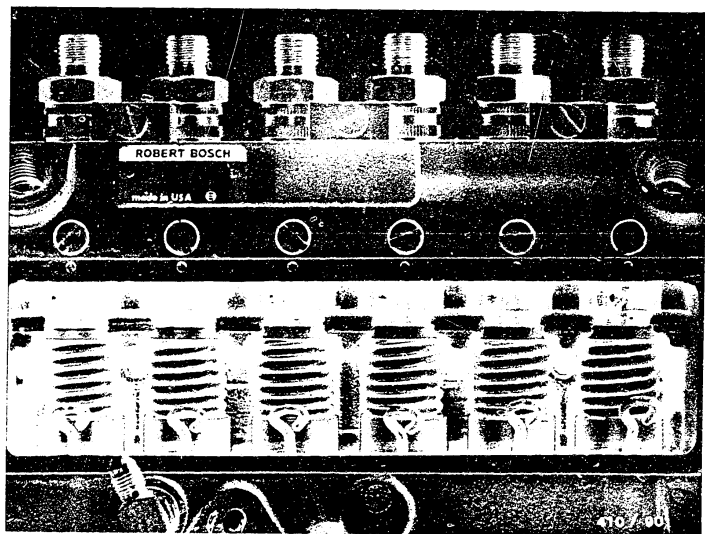

### Series S-3000

Turn camshaft with holding wrench KDEP 2906 and, with the respective cam at TDC, fix roller tappet in place with tappet holder KDEP 2995 (see picture).

Position tappet holder so that the ground side points toward the pump housing seating surface.

**B6**

Dismantling the Injection Pump  
PE(S)..A., 0 410 ..



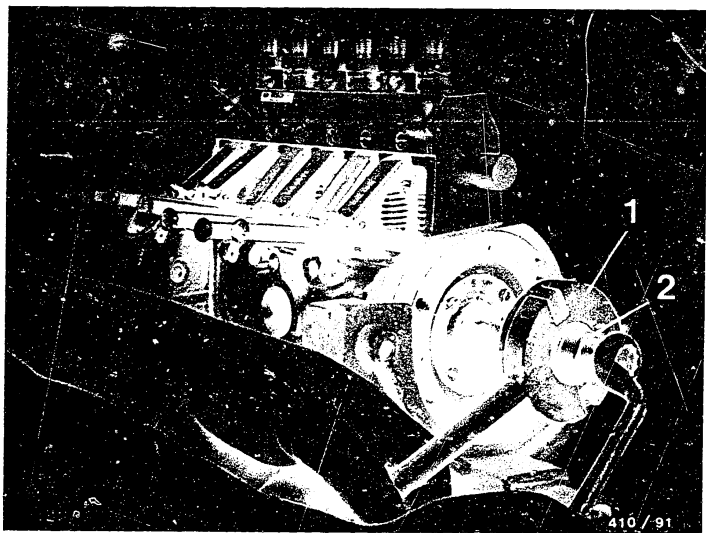

1 = Holding wrench KDEP 2906      2 = Puller KDEP 2918

Remove drive coupling and Woodruff key.

If stuck, loosen coupling from camshaft cone in conjunction with holding wrench KDEP 2906 and puller KDEP 2918 (see picture).

**B7**

Dismantling the Injection Pump  
PE(S)..A.., 0 410 ..



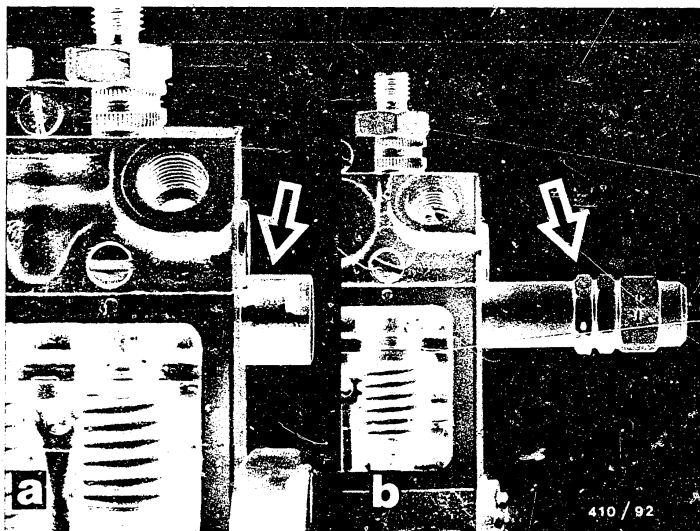

Unscrew fixed control-rod stop (see picture a) or spring-loaded stop (see picture b).

Remove control-rod stop screw with lock nut.

Tilt injection pump (90°).

**B8**

Dismantling the Injection Pump  
PE(S)..A., 0 410 ..





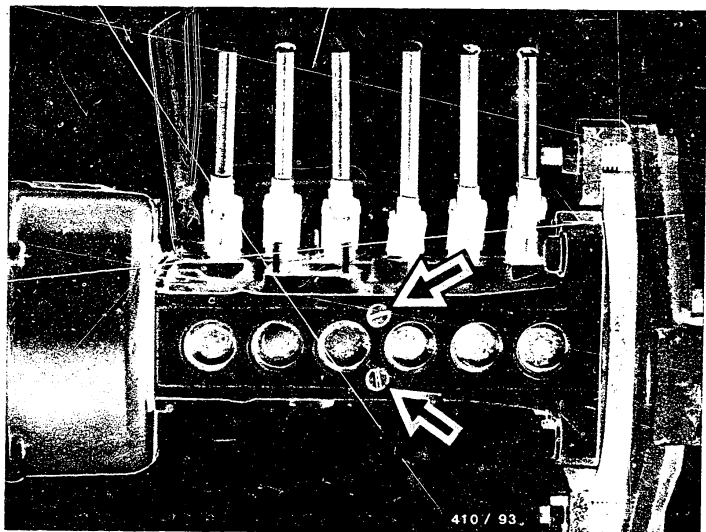

Unscrew camshaft intermediate bearing fastening screws (see picture, arrow).

Note:

One intermediate bearing is installed as of 6/8 cylinder injection pumps of series S-2000/3000.

Two intermediate bearings are installed as of 10/12 cylinder injection pumps of series S-2000/3000.

**B9**

Dismantling the Injection Pump  
PE(S)..A..., 0 410 ..



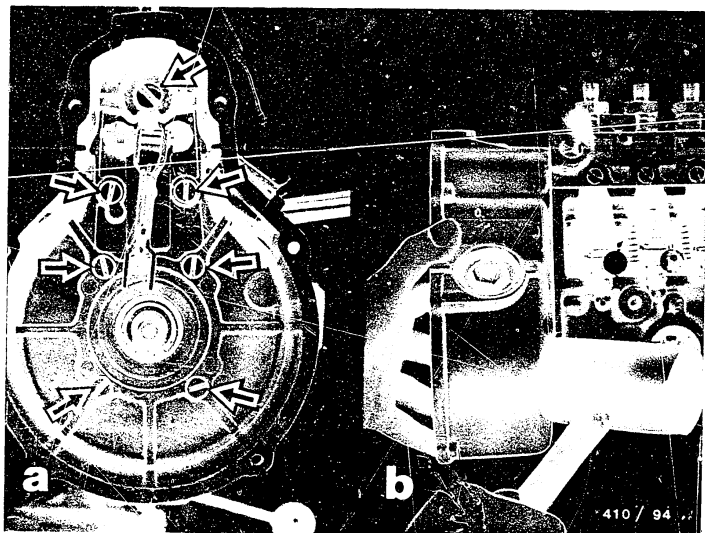

Unscrew governor housing fastening screws (see picture a - arrows).

By carefully tapping on both sides (with plastic hammer), separate governor housing from pump housing (see picture b).

**B10**

Dismantling the Injection Pump  
PE(S)..A.., 0 410 ..



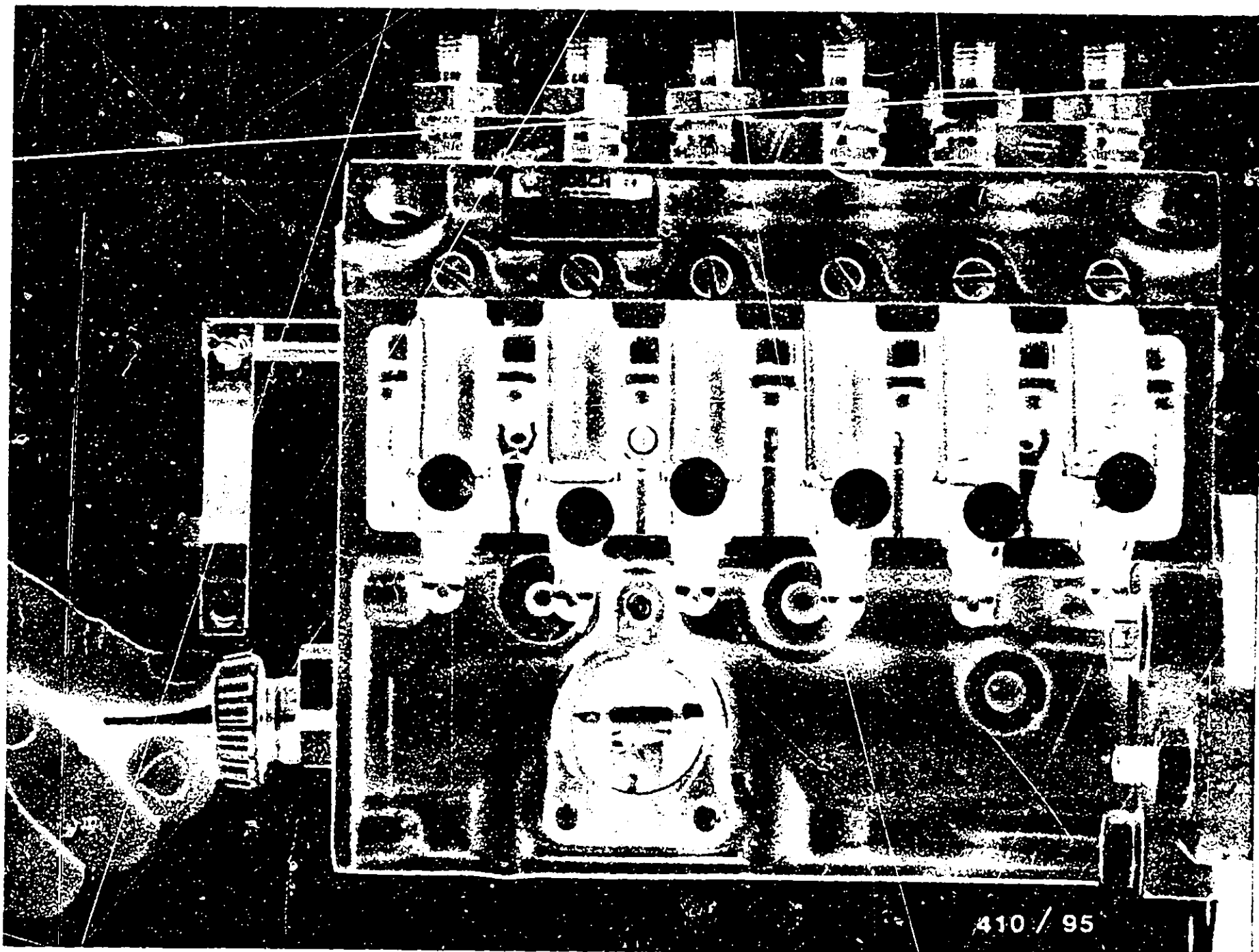

Pull camshaft with intermediate bearing (if applicable) out of camshaft chamber.

**B 11**

Dismantling the Injection Pump  
PE(S)..A.., 0 410 ..



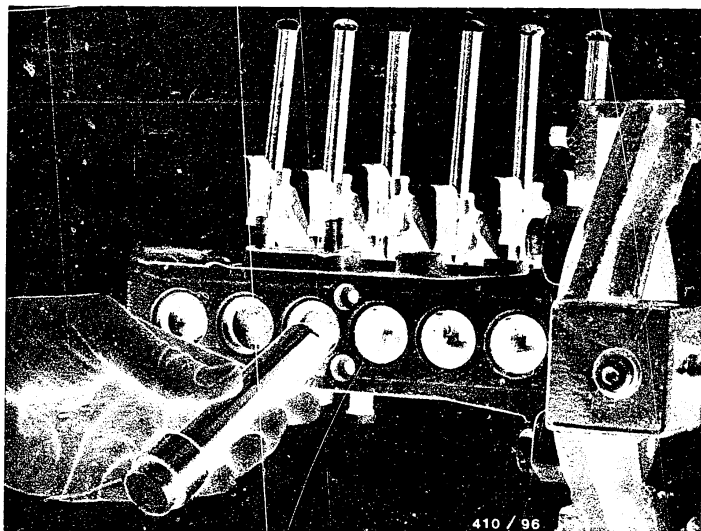

Using mandrel KDEP 1585, knock through base closing covers into the camshaft chamber and take out from the side.

**B12**

Dismantling the Injection Pump  
PE(S)..A.., 0 410 7..



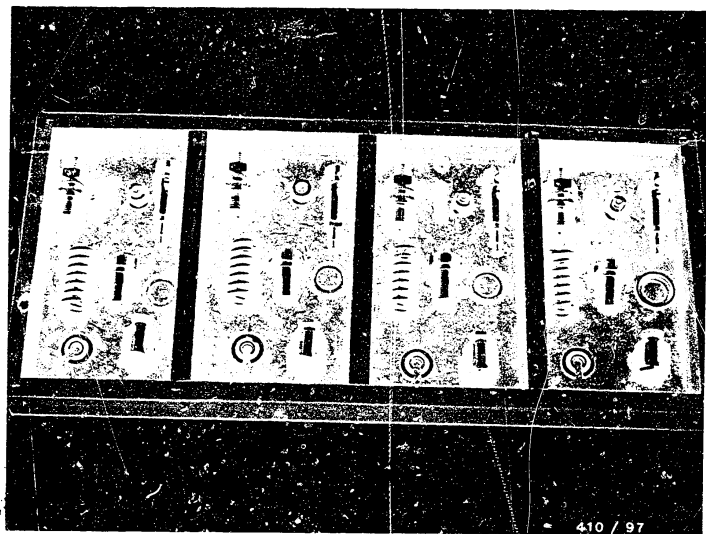

In the following operations, place all components of the same barrel assembly on a clean compartment-type tray (see picture for example), or use similarly suitable storage boxes.

**B 13**

Dismantling the Injection Pump  
PE(S)..A.., 0 410 ..



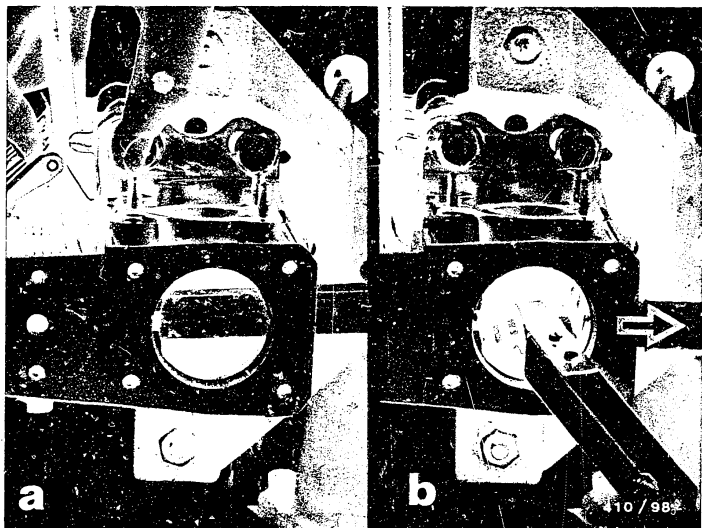

Hold roller tappet with pressure-piece KDEP 2941 and remove tappet holder (see picture a).

Relieve pressure on pressure-piece and, using tappet forceps KDEP 2941, take roller tappet out of camshaft chamber from the side (see picture b).

**B14**

Dismantling the Injection Pump

PE(S)..A.., 0 410 ..



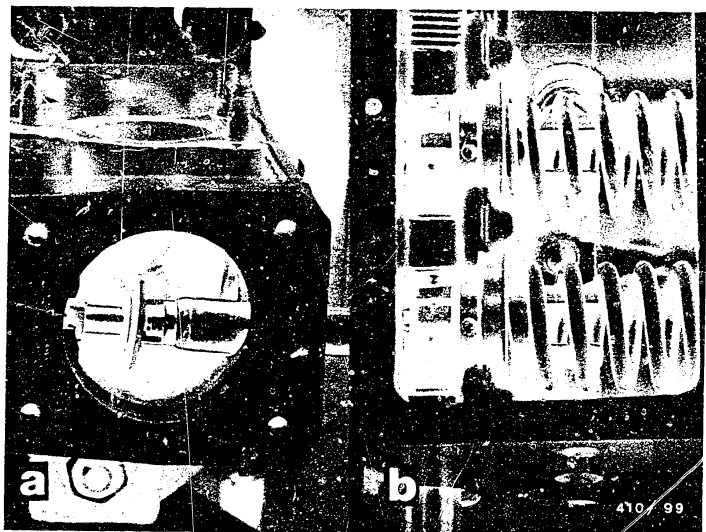

Using plunger pliers KDEP 2915, carefully remove pump plunger together with lower spring seat through the base closing cover opening (see picture a).

Then remove plunger spring, upper spring seat and control sleeve (see picture b).

**B 15**

Dismantling the Injection Pump  
PE(S)..A.., 0 410 ..



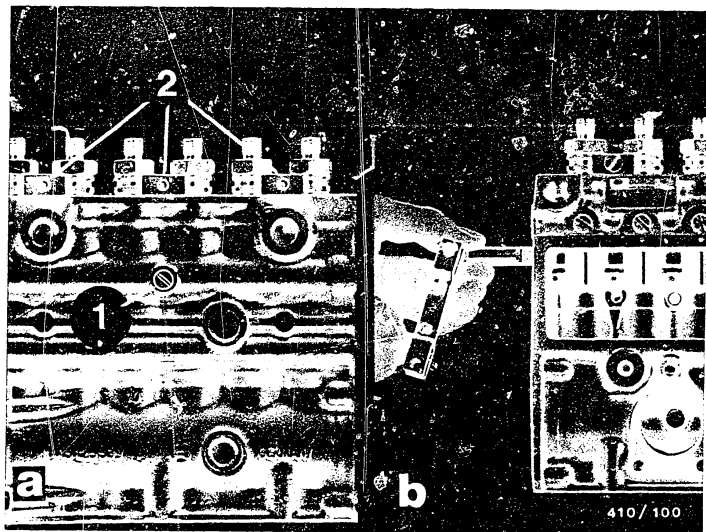

- 1 = Locating screw for control rod  
2 = Clamping jaws

Unscrew control rod locating screw (see picture a) and then pull control rod out of pump housing (see picture b).

Remove clamping jaws between delivery-valve holders (see picture a).

**B16**

Dismantling the Injection Pump  
PE(S)..A.., 0 410 ..





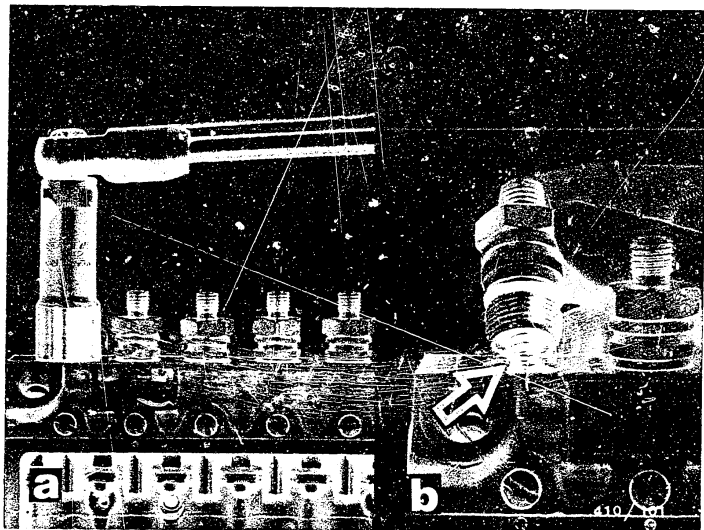

Unscrew delivery-valve holders (see picture a) and lay to one side together with compression spring (see picture b - arrow).

Note:

Depending on the version of pump, there may be a filler piece (possibly with shims) in the delivery-valve holder.

See the respective service-parts list for correct delivery-valve holder equipment.

**B 17**

Dismantling the Injection Pump

PE(S)..A., 0 410 ..



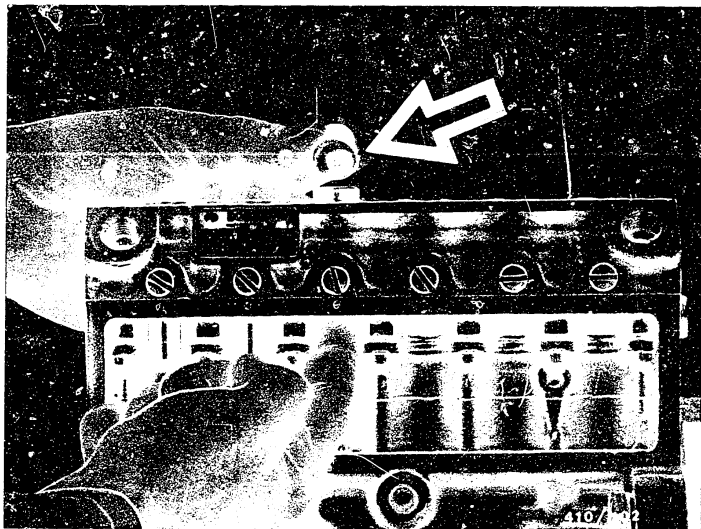

Press up the pump barrel from underneath (see picture).

Take off delivery valve (see picture, arrow) and lay in corresponding compartment of storage tray with pump barrel.

Note:

Due to their accuracy of fit (mated), pump barrels and pump plungers must not be mixed up.

**B 18**

Dismantling the Injection Pump  
PE(S)..A.., 0 410 ..



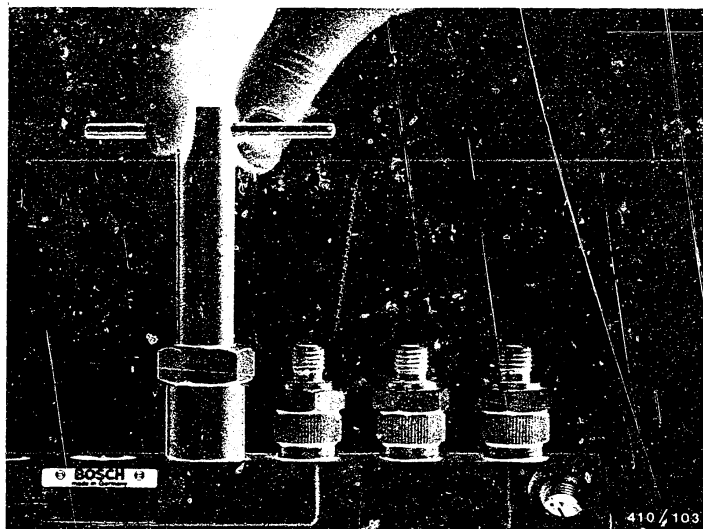

### Delivery valve with double seal

To remove the delivery valve, use valve lifter KDEP 2892 (M 12 x 1) or KDEP 2977 (M 14 x 1) (see picture).

Then press up pump barrel from underneath and lay in corresponding compartment of storage tray with delivery valve.

**B 19**

Dismantling the Injection Pump  
PE(S)..A.., 0 410 ..



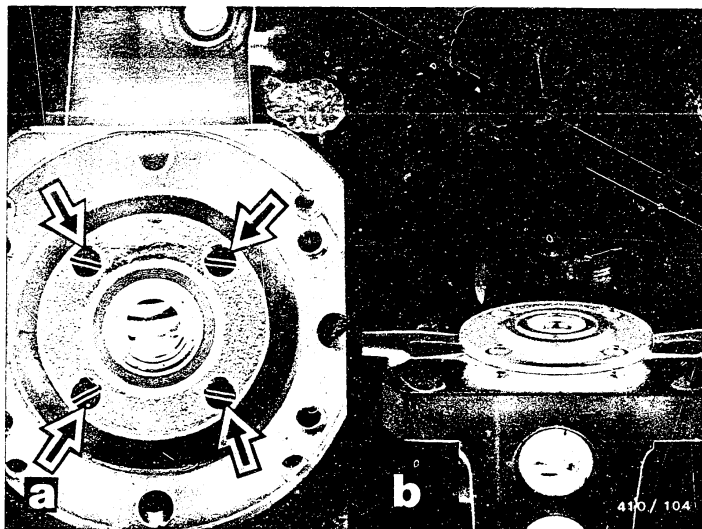

Remove bearing end plate fastening screws (see picture, arrows).

Using screwdriver, lever bearing end plate evenly out of pump housing.

Note:

To do this, unscrew end-flange-mounted injection pumps from clamping flange.

**B20**

Dismantling the Injection Pump

PE(S)..A.., 0 410 ..



## 8. Cleaning the components

Wash the components in low-inflammability, commercially available cleaning agent e.g. Chlorothene NU.  
Then blow out with compressed air.

### Observe the following safety regulations

Decree on Working with Combustible Liquids (Vbf) issued by the Federal Ministry of Labor (BmA).

Safety Rules for Handling Chlorinated Hydrocarbons

for the Workshop ZH 1/222

for the Employee ZH 1/119

issued by the Central Association of German Employers' Liability Insurance Associations (Central Association for Accident Prevention and Industrial Medicine)  
Langwartweg 103, 5300 Bonn 5.

In countries outside the Federal Republic of Germany, observe the corresponding local regulations.

**B21**

Cleaning the Components - Safety Reg.  
PE(S)..A.., 0 410 ..



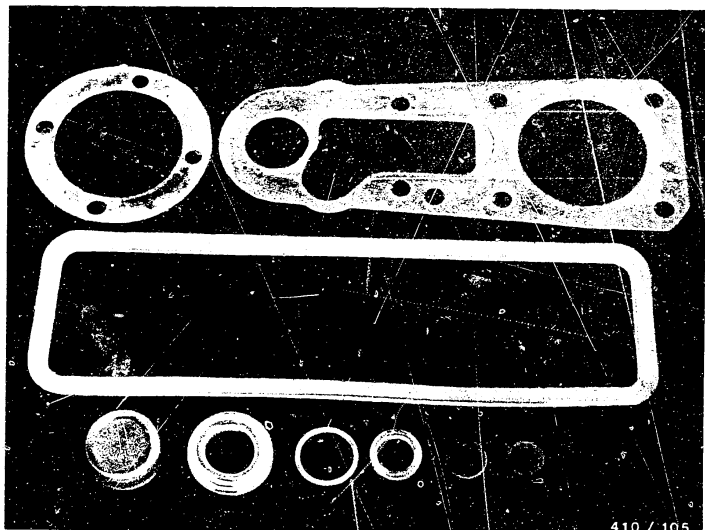

### 9. Checking the components

Worn or damaged components must be replaced.

Flat flange gaskets, radial-lip-type oil seals, O-rings, base plugs and copper seal rings (see picture) must always be replaced.

**B22**

Checking the Components  
PE(S)..A.., 0 410 ..



Identification of injection-pump service parts with a part of the part number

The following explanatory remarks are intended to enable a comparison between the 10-digit part number and the number which is stamped or inscribed on the service part. This makes it possible to identify incorrectly installed components.

Identification is as follows:

Camshaft

1st and 6th to 10th digits of the part number, e.g.

<u>Part Number</u>	<u>Identification</u>
1 416 126 302	126 302

Plunger-and-barrel Assembly

1st and 5th to 10th digits of the part number, e.g.

<u>Part Number</u>	<u>Identification</u>
1 418 325 010	1 325 010

The inscription on the plunger-and-barrel assembly is such that side 1 of the plunger control arm bears the 1st and 5th to 7th digits and side 2 of the plunger control arm bears the 8th to 10th digits of the part number.



Delivery valve

Identification is by 6 digits whereby the 1st digit represents a factory-internal code number and the remaining 5 digits are the 6th to 10th digits of the part number, e.g.

Part Number

Identification

1 418 524 005

124 005

The valve cone is inscribed as before.

Inscription is such that the first 3 digits of the identification are in the longitudinal groove and the remaining 3 digits are in the longitudinal groove opposite.

In delivery valves with cylindrical cone, the identification is either on the end face of the cone or on the valve holder.





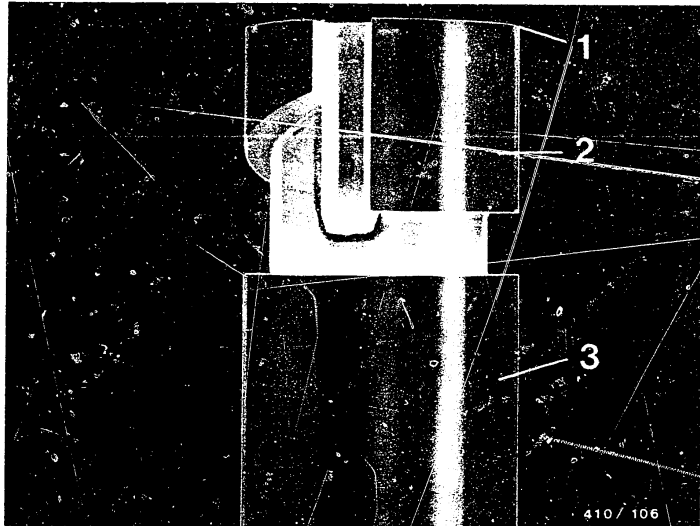

1 = Helix      2 = Head region      3 = Bearing surface

Checking the plunger-and-barrel assembly

Replace plunger-and-barrel assemblies if they exhibit the following features:

- rounded helixes
- dull spots in head region
- wear marks on bearing surfaces
- plungers sticking (detectable by glide test)

Note:

Prior to the glide test on the plunger-and-barrel assembly, wash plunger and barrel in calibrating oil. Hold pump plunger and pump barrel more or less vertical. The pump plunger must glide down under its own weight.

**C1**

Checking the Components  
PE(S)..A.., 0 410 ..



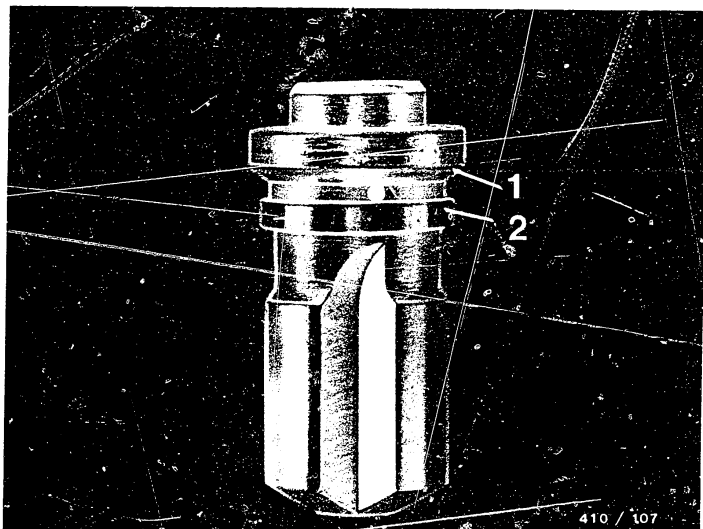

1 = Valve cone      2 = Retraction piston

### Checking the delivery valves

The seating surface of the valve cone must not be pounded in or unevenly worn.

If the retraction piston is damaged (score marks) or if the valve is sticking in the valve holder, replace delivery valve.

**C2**

Checking the Components  
PE(S)..A.., 0 410 ..



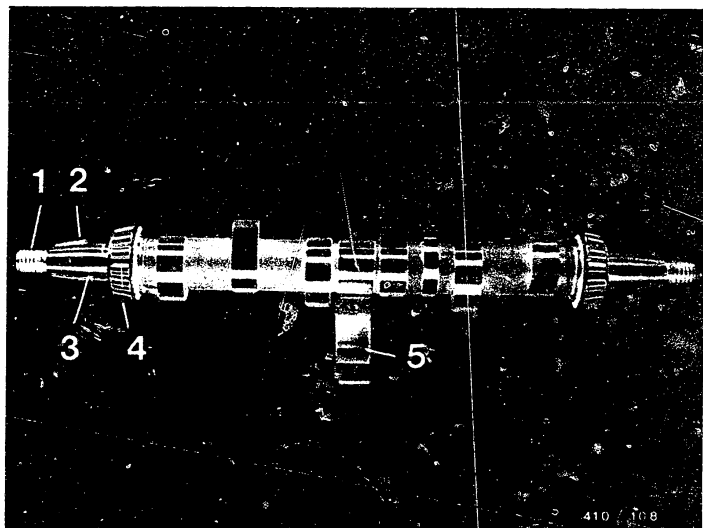

- 1 = Threaded shaft end
- 2 = Woodruff key groove
- 3 = Cone

- 4 = Camshaft bearing
- 5 = Intermediate bearing

### Checking the camshaft

Visually examine the camshaft for:

- heavy wear marks on cams
- worn, damaged Woodruff key groove
- damage to threaded shaft end or cone.

If the following damage is applicable, replace camshaft.

#### Note:

Always replace camshaft bearings whenever carrying out repairs. Intermediate bearings which exhibit score marks should also be replaced.

**C3**

Checking the Components  
PE(S)..A.., 0 410 ..



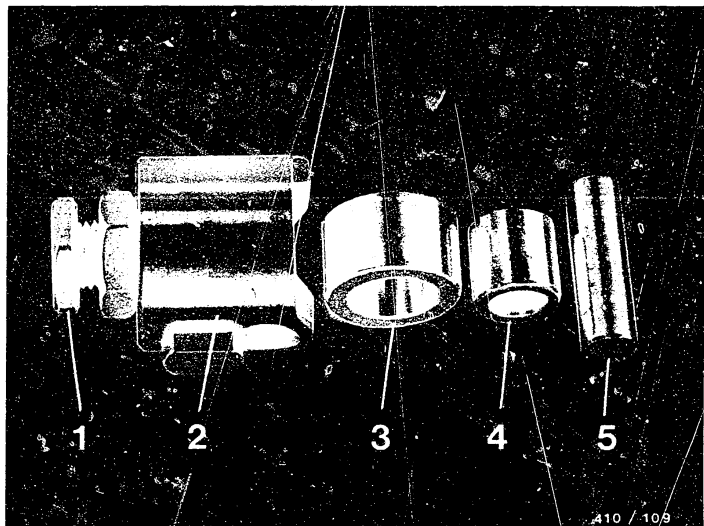

1 = Tappet screw

2 = Roller-tappet shell

3 = Roller

4 = Bearing bushing

5 = Bearing pin

### Checking the roller tappets

Replace roller tappets/individual components if the following damage is applicable:

- pounded-in tappet screw
- heavy wear marks on roller-tappet shell
- heavy wear marks and/or discoloration on roller, bearing bushing and bearing pin.

**C4**

Checking the Components

PE(S)..A..., 0 410 ..



Note:

If there are heavy wear marks on the roller-tappet shell, check the roller tappet guide in the pump housing for score marks.

If installing a new roller tappet and/or a new tappet screw, set the tappet screw to the old projection dimension.

Final setting is performed on the test bench.

**C5**

Checking the Components

PE(S)..A.., 0 410 ..



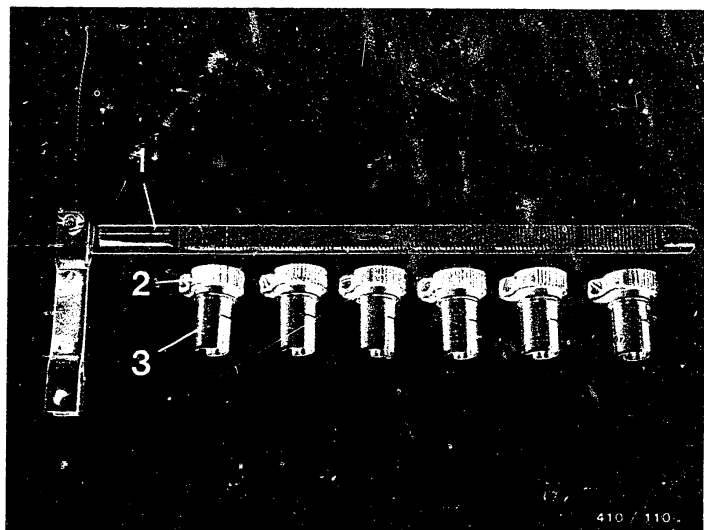

1 = Control rod      2 = Ring gear      3 = Control sleeve

Checking the control rod and control sleeves

If the teeth of ring gears/control rod or the slits of control sleeves for the plunger control arms are worn/damaged, replace.

**C6**

Checking the Components  
PE(S)..A.., 0 410 ..



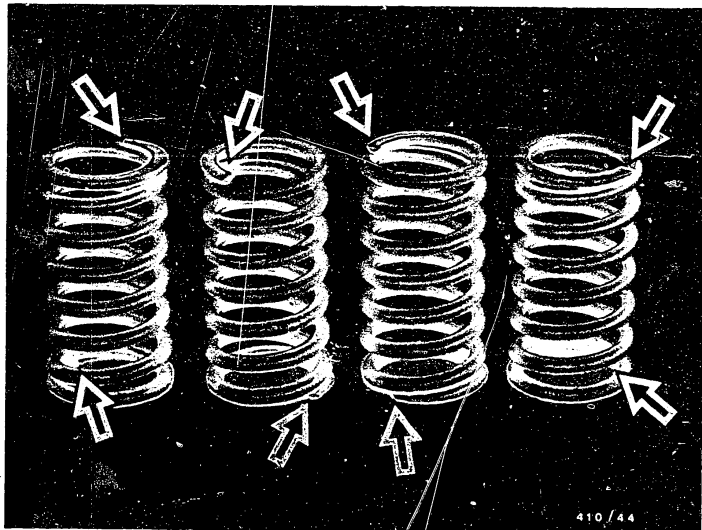

### Checking the plunger springs

Plunger springs, which are corroded or whose surface is damaged, must be replaced due to the danger of breakage.

Check particularly the seating surface of the first turn (see picture, arrows).

**G7**

Checking the Components

PE(S)...A..., 0 410 ..



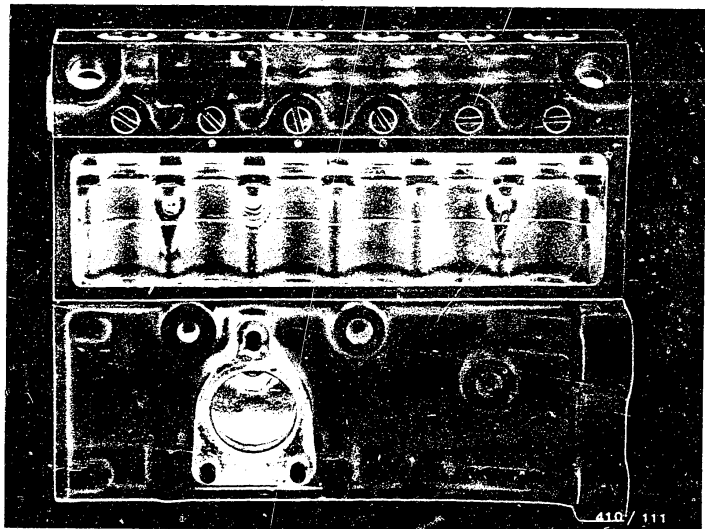

### Checking the pump housing

Check housing for cracks and other external damage.

Check the following in particular:

- threads on stay bolts and inserts
- score marks on roller tappet guides
- freedom of movement of control rod in its guide
- cavitation in suction gallery
- unevenness/fuel deposits on seats of plunger-and-barrel assemblies.





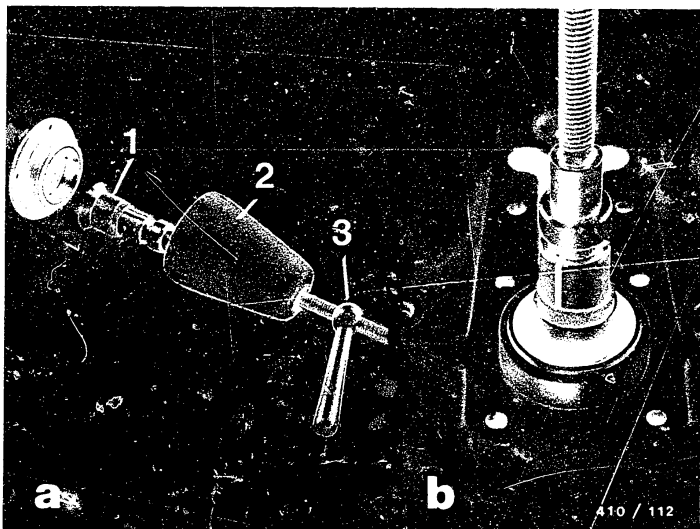

- 1 = Spring collet
- 2 = Puller bell
- 3 = Threaded pin

## 10. Repairing the injection pump

### 10.1 Replacing the bearing outer races

Using spring collet, threaded pin and puller bell (see picture a), pull bearing outer races out of drive end shield and governor housing (see picture b).

#### Note:

Use puller tools from tool board KDAW-T 100.

**C9**

Repairing the Injection Pump

PE(S)..A..., 0 410 ..



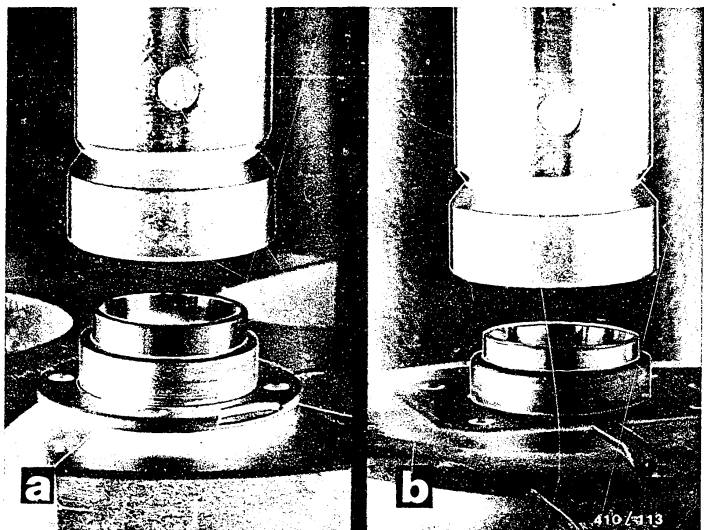

Under an arbor press, press in new bearing outer races as far as the bearing seat in the drive end shield (see picture a) and governor housing (see picture b).

**C10**

Repairing the Injection Pump  
PE(S)..A.., O 410 ..



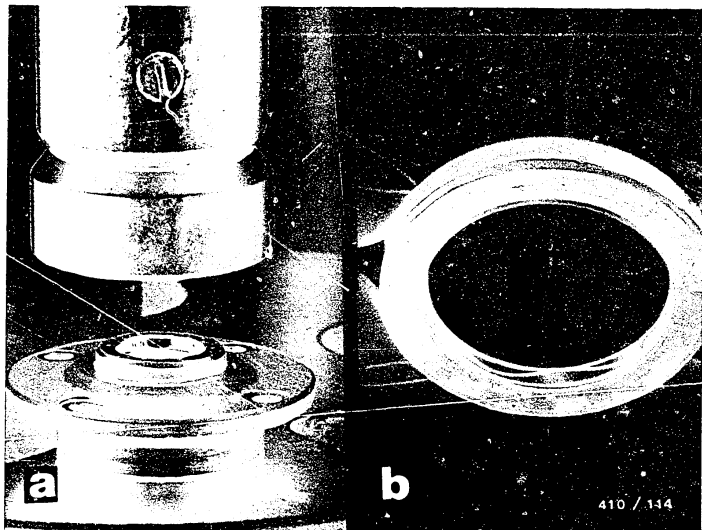

### 10.2 Replacing the radial seals

Lightly oil outside of new radial-lip-type oil seal and press flush into drive end shield (see picture a).

#### Note:

In versions of pump with alternating-spiral seal (see picture b), cone and sealing surface must be grease-free when inserting the camshaft.

Pack double-lip seal between the sealing lips with high-temperature bearing grease 5 700 002 025.

**C11**

Repairing the Injection Pump  
PE(S)..A., 0 410 ..



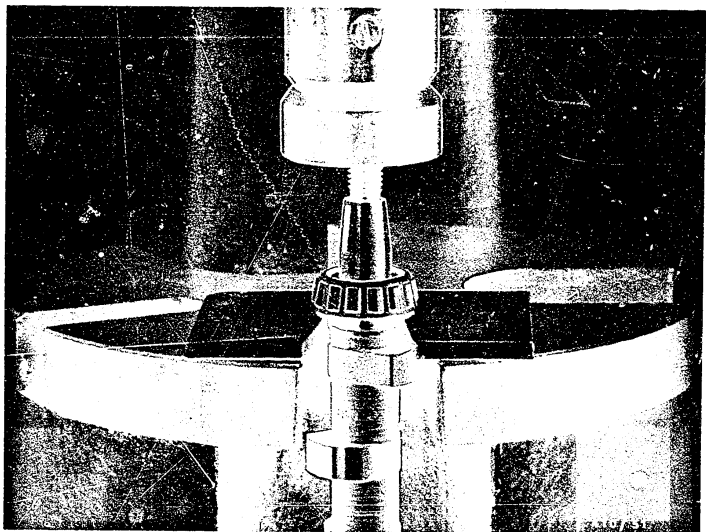

### 10.3 Replacing the camshaft bearings

Under an arbor press, force off camshaft bearing using forcing-off plate KDEP 1580.

Note:

The forcing-off plate is suitable for all camshaft diameters.

Therefore, slide camshaft into recess until the bearing collar rests on both sides (see picture).



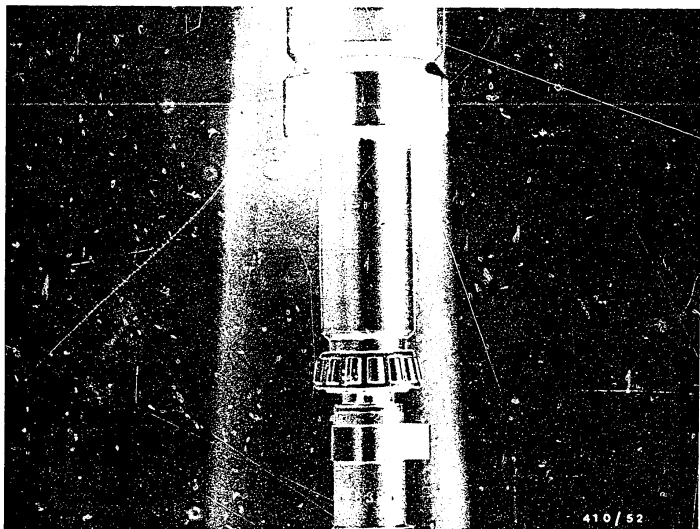

Under an arbor press, press on new camshaft bearings using press-on sleeve KDEP 1582 or 1583. Re-use existing axial-play-adjusting shims at the same end.

Note:

Press-on sleeve KDEP 1582 can be used for 17 and 20 mm cone.

Press-on sleeve KDEP 1583 can be used for 25 and 30 mm cone.

**C13**

Repairing the Injection Pump  
PE(S)..A., 0 410 ..



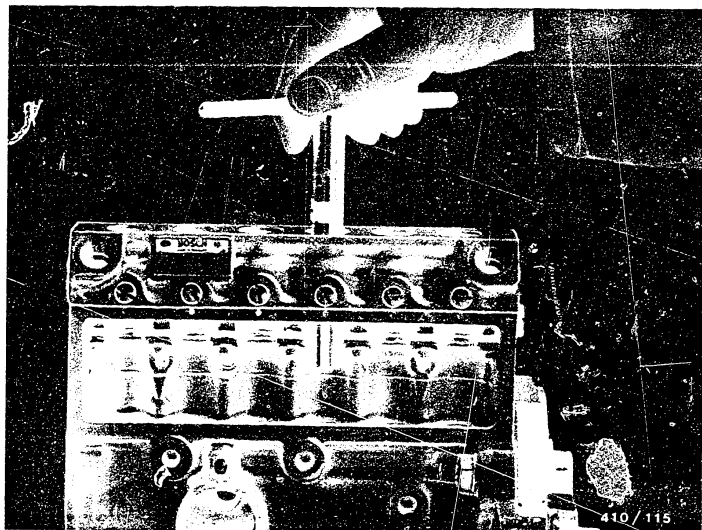

#### 10.4 Reworking the seats of the plunger-and-barrel assemblies

Using hand milling cutter KDEP 2951, 2952 or 2955 (depending on diameter of plunger-and-barrel assembly seats), carefully - and without exerting any great pressure - recut (flatten) the seats in order to eliminate any unevenness/fuel deposits.

Note:

After reworking, wash out the pump housing in cleaning agent.

**C14**

Repairing the Injection Pump  
PE(S)..A..., 0 410 ..





### 10.5 Replacing the ring gear on the control sleeve

Replace ring gears if worn (by loosening the clamping screw, see picture, arrow).

Tighten clamping piece of new ring gear centralized on the control sleeve (see picture).

Holes for turning the control sleeve must point forward.

**C15**

Repairing the Injection Pump

PE(S)..A.., 0 410 ..



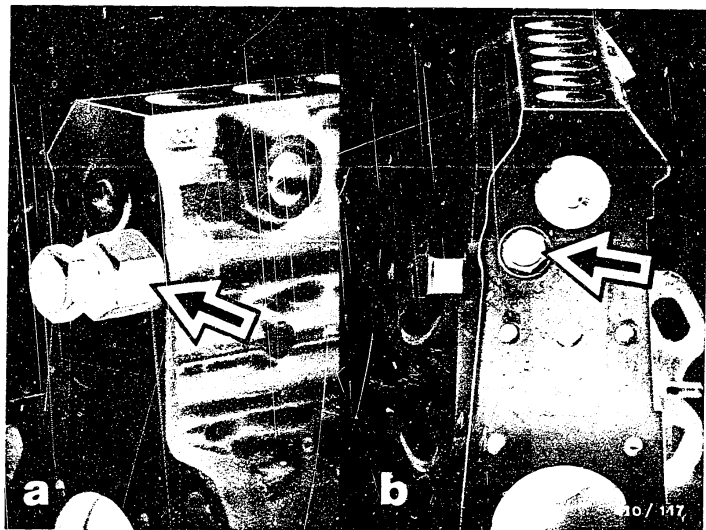

### 10.6 Replacing worn control-rod guide bushings

To do this, unscrew threaded bushing with KDEP 2859 (see picture a) and threaded ring with 12 mm hexagon-socket-screw key (see picture b - arrow).

**C16**

Repairing the Injection Pump  
PE(S)..A., 0 410 ..





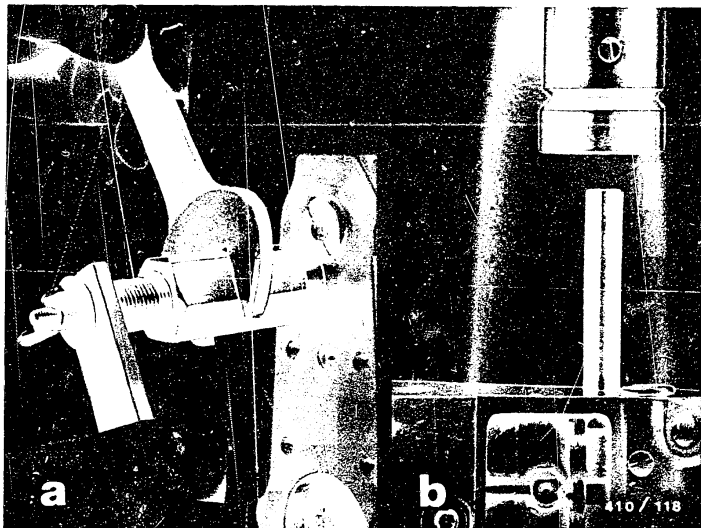

Remove both control-rod guide bushes, using a puller device KDEP 1056 (see Fig. a).

Press the new guide bushes into the pump housing by means of a press-in mandrel KDEP 1584 (see Fig. b).

**C17**

Repairing the injection pump  
PE(S)..A., 0 410 ..



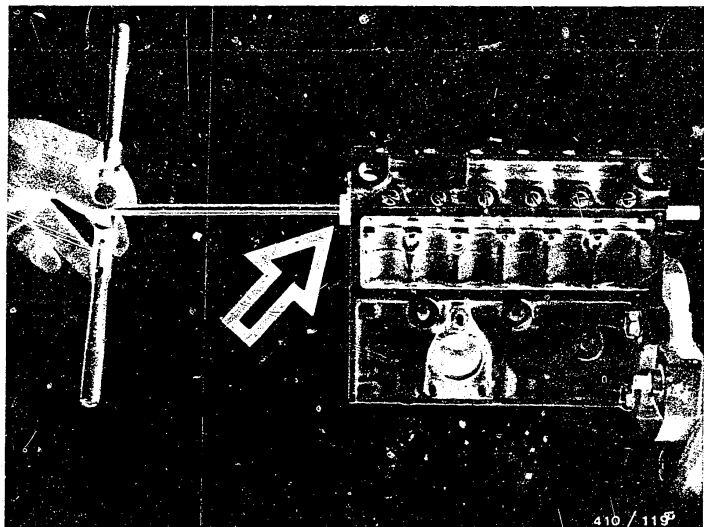

Clamp pump housing according to type of mounting.

Using reamer KDEP 2999 and guide sleeve (see picture, arrow), ream control-rod guide bushings to diameter of control rod.

Note:

After the guide bushings have been reamed, the control rod must move easily without tilting.

- Wash out the pump housing thoroughly.

**C18**

Repairing the Injection Pump  
PE(S)..A.., 0 410 ..



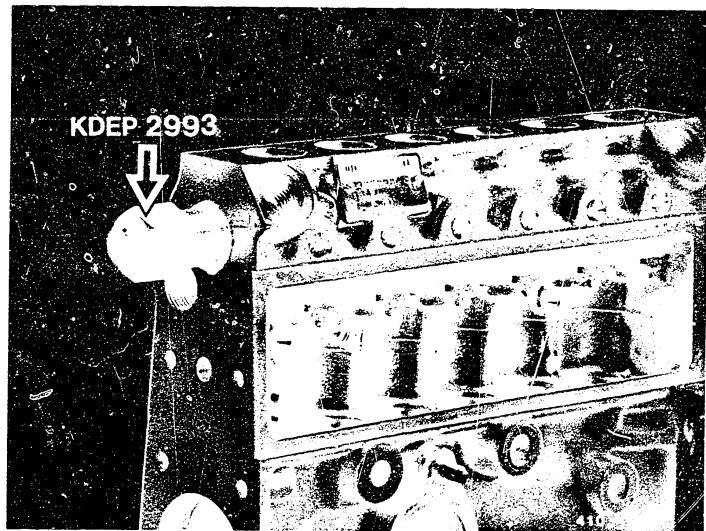

### 10.7 Replacing the screw plug on the unused fuel inlet

Using screwing device KDEP 2993, unscrew leaking screw plug on unused fuel inlet.

Re-insert screw plug with sealant (Loctite) and tighten to 60...70 Nm.

**C19**

Repairing the Injection Pump

PE(S)...A..., 0 410 ..



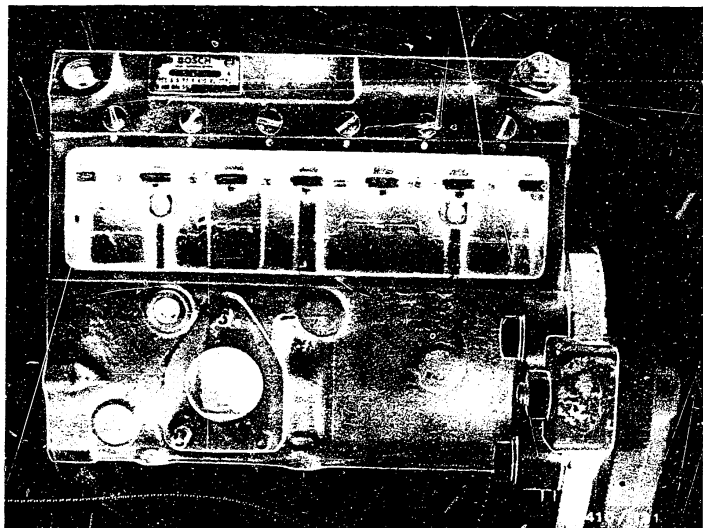

### 11. Assembling the Injection Pump

Clamp injection pump housing according to type of mounting.

In the following operations, use only components which have been cleaned and which are not worn or damaged..

**C20**

Assembling the Injection Pump  
PE(S)..A., 0 410 ..



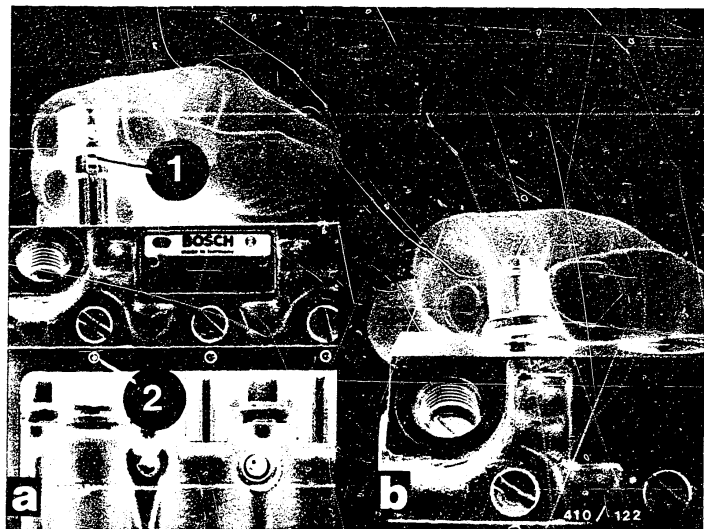

1 = Guide groove

2 = Locating pin

### 11.1 Installing the pump barrels and delivery valves

Insert pump barrel into housing so that locating pin engages guide groove (see picture a):

This makes sure that the barrel cannot turn.

Insert delivery valves with new O-rings in pump housing (see picture b).

**C21**

Assembling the Injection Pump  
PE(S)..A..., 0 410 ..

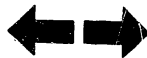

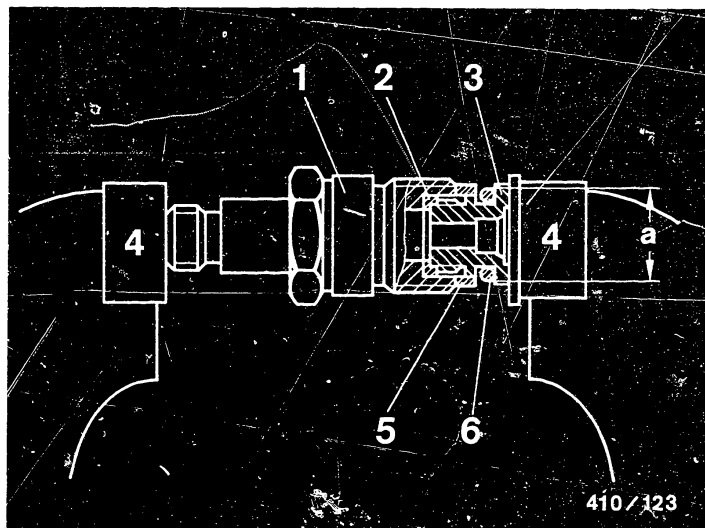

### Delivery valve with double seal

$a = 18.4 \dots 18.6 \text{ mm}$

- |                           |                                       |
|---------------------------|---------------------------------------|
| 1 = Delivery-valve holder | 4 = Protective jaws or<br>ground jaws |
| 2 = Gasket                | 5 = Thrust ring                       |
| 3 = Delivery valve        | 6 = O-ring                            |

In injection pumps with a double seal on the delivery valve, the seal on the low-pressure side is by means of an O-ring and the seal on the high-pressure side by means of a bronze gasket.

To obtain the correct contact pressure on the low-pressure side, check the sealing dimension (a) of the O-ring before inserting in the pump housing.



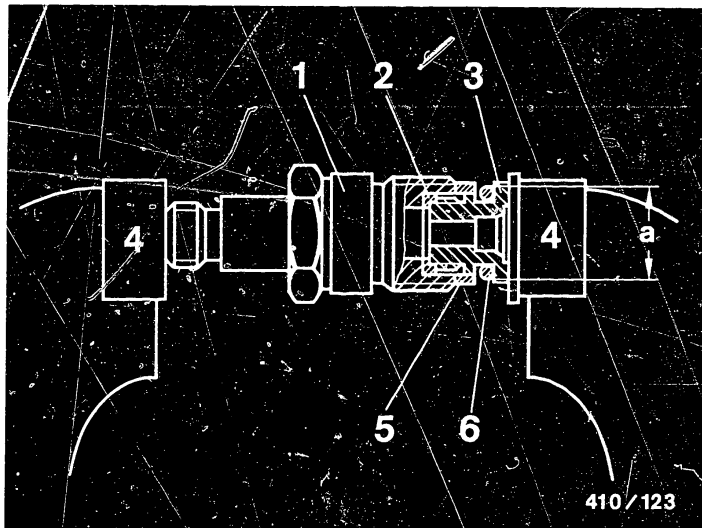

- |                           |                                       |
|---------------------------|---------------------------------------|
| 1 = Delivery valve holder | 4 = Protective jaws or<br>ground jaws |
| 2 = Gasket                | 5 = Thrust ring                       |
| 3 = Delivery valve        | 6 = O-ring                            |

Press together delivery valve with O-ring, thrust ring, bronze gasket and delivery-valve holder in vise (use protective jaws or ground jaws) until the delivery-valve holder is seated on the bronze gasket.

Measure outside diameter of compressed O-ring:  
Specification: 18.4 ... 18.6 mm

Adjust dimension by selecting an appropriate thrust ring.



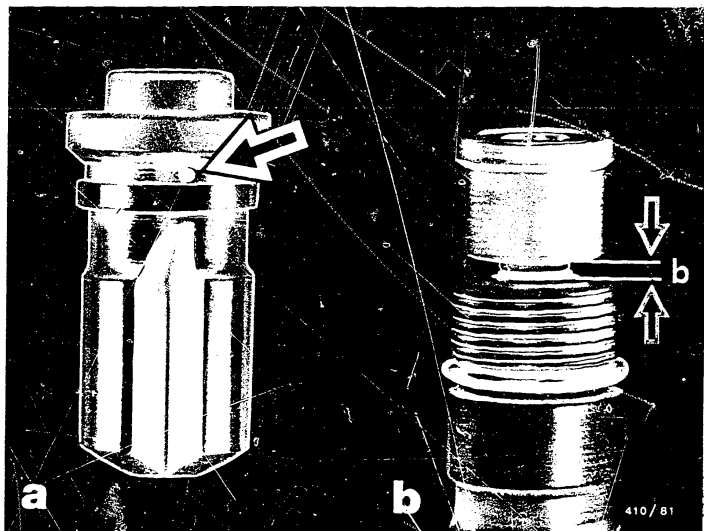

### Adjusting the spring preload of torque-control delivery valves

Torque-control delivery valves can be identified by the idle bore (see picture a - arrow).

Check the spring preload as follows:

- clamp delivery-valve holder in vise with spring chamber at top.
- insert filler piece (if applicable) and compression spring.
- mount delivery valve with valve holder and seal ring.
- measure dimension "b" (see picture b). If the spring preload specification in the test-specification sheet is not obtained, add shims.

If the dimension is too great, change shims or, if necessary, compression spring.





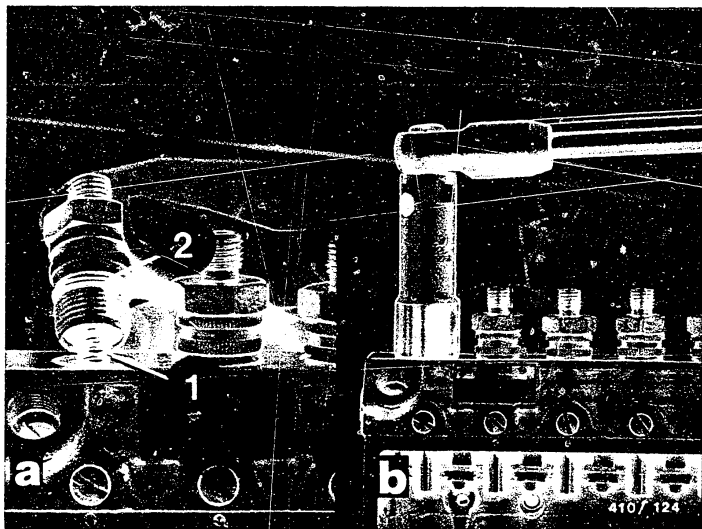

1 = Compression spring

2 = O-ring

Screw delivery-valve holder with compression spring and O-ring (also with filler piece, if applicable) into housing (see picture a).

Depending on version, tighten delivery-valve holders to specified torque and in the specified tightening sequence (see picture b).

Tightening torques:

Delivery-valve holders without identification groove (PE(S)..A..C..)

45-0-45-0-45...50 Nm

with identification groove (PE(S) 2...6 A.. D.. )

40-0-40-0-40...50 Nm

with identification groove (PE(S) 8...12 A.. D..)

30-0-30-0-33...37 Nm

with nylon seal ring (PE(S)..A..C..)

45 ... 50 Nm

**D1**

Assembling the Injection Pump  
PE(S)..A.., 0 410 ..



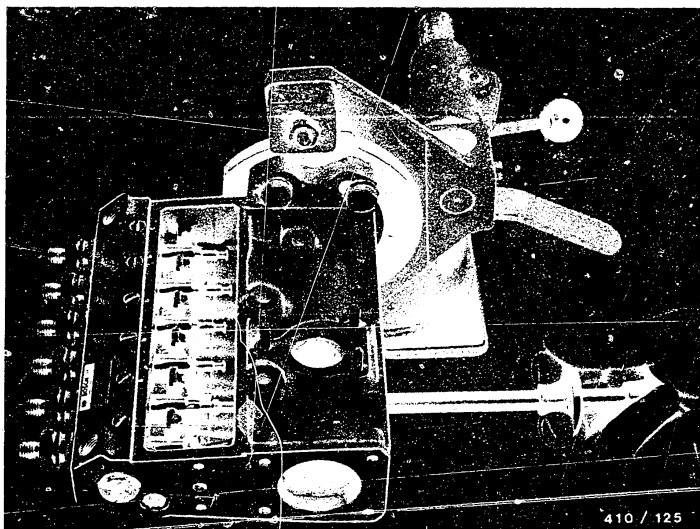

### 11.2 Leak test on suction gallery

#### Preparations:

Tilt housing (90°).

Wet pump plungers with calibrating oil and insert into pump barrels using plunger pliers KDEP 2915.

Check pump plungers for freedom of movement.

#### Note:

If stiff, remove plunger-and-barrel assembly and recut (flatten) seat once again.

**D2**

Assembling the Injection Pump

PE(S)..A..., 0 410 ..



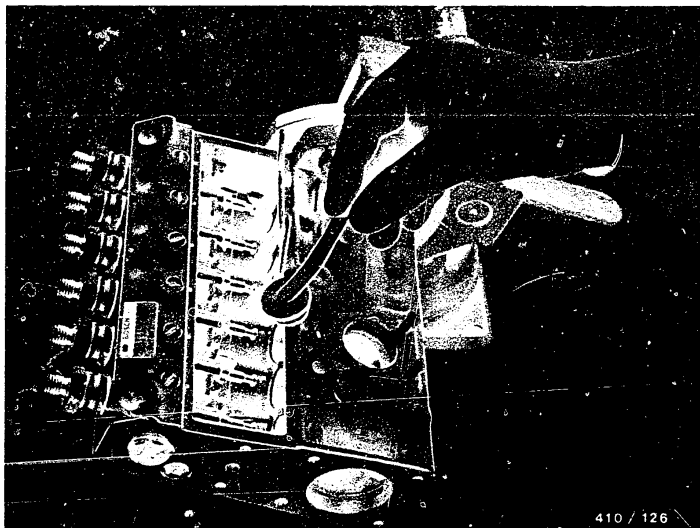

Limit plunger stroke by inserting support plates  
KDEP 1581 (see picture).

**D3**

Assembling the Injection Pump  
PE(S)..A.., 0 410 ..



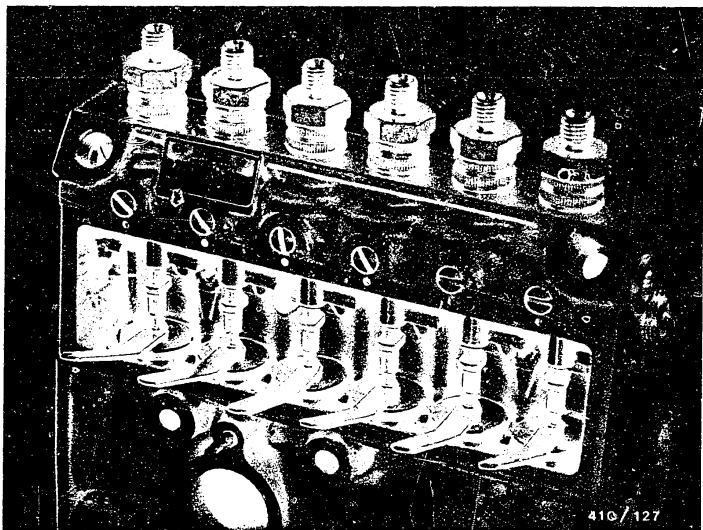

Unscrew housing from clamping support.

Before immersing in calibrating oil, connect pump housing to workshop compressed-air mains through pressure regulator with water trap.

To obtain the specified pressure reduction during the leak test, insert directional-control valve KDJE-P-100/1 of pressure tester KDJE-P 100 into compressed-air inlet.

Seal unused fuel inlet connections.

**D4**

Assembling the Injection Pump  
PE(S)..A.., 0 410 ..



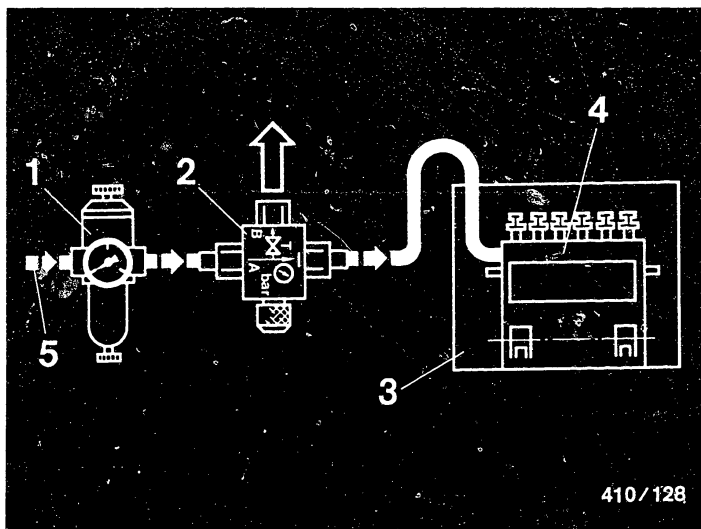

410/128

- 1 = Pressure regulator with pressure gauge 0...6 bar and water trap
- 2 = Directional-control valve KDJE-P 100/1
- 3 = Immersion tank with calibrating oil
- 4 = Injection pump
- 5 = Compressed air

### Leak test on suction gallery

Immerse housing vertically into oil bath. Openings of delivery-valve holders must not, however, be below the level of the calibrating oil. Only in order to locate any leaks, pivot the housing.

Leaks in the region of the suction gallery are not allowable. Watch in particular for leaks at plunger-and-barrel assembly seats and at O-ring seals. This does not apply to leaks between plunger and barrel.

**D5**

Assembling the Injection Pump  
PE(S)..A.., 0 410 ..



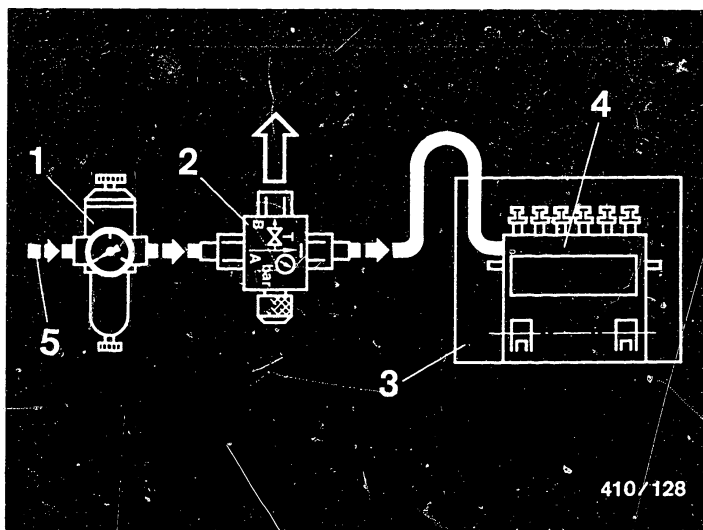

- 1 = Pressure regulator with pressure gauge 0...6 bar and water trap
- 2 = Directional-control valve KDJE-P 100/1
- 3 = Immersion tank with calibrating oil
- 4 = Injection pump
- 5 = Compressed air

Test duration and test pressure:  
4 minutes at 5 bar

If there is a leak at a plunger-and-barrel assy seat, unscrew delivery-valve holder, remove barrel and recut (flatten) seat with hand milling cutter KDEP 2951, 2952 or 2955.  
Repeat leak test.

Note:

To prevent skin rashes, grease hands beforehand with protective skin cream and wash with soap and water after testing.

**D6**

Assembling the Injection Pump  
PE(S)..A.., 0 410 ..



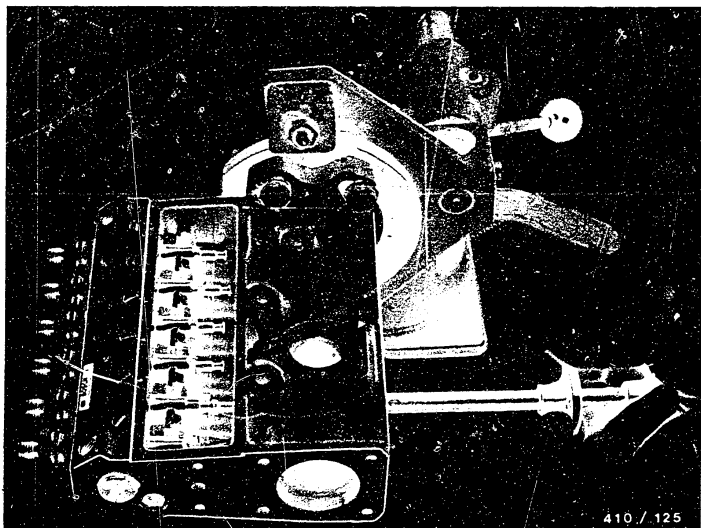

Remove compressed-air connection from pump housing.

Clamp pump housing according to type of mounting and tilt.

Remove support plates KDEP 1581.

Using plunger pliers KDEP 2915, pull plungers out of barrels and lay in storage tray of barrel assembly.

**D7**

Assembling the Injection Pump  
PE(S)..A.., 0 410 ..



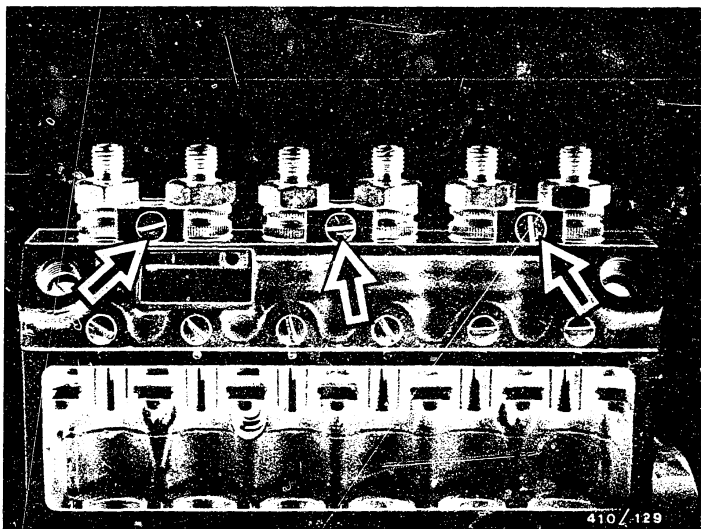

Mount clamping jaws (see picture, arrows).  
Tighten fillister-head screws to 5...6.5 Nm.

**D8**

Assembling the Injection Pump  
PE(S)..A.., 0 410 ..





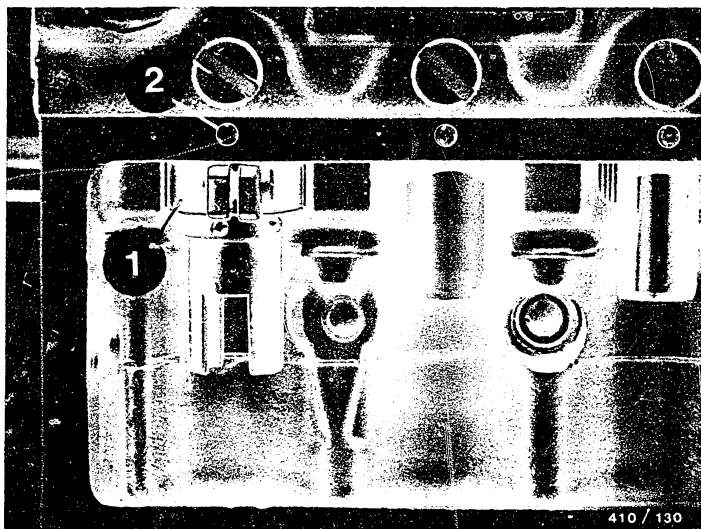

1 = Ring gear

2 = Locating pin

### 11.3 Mounting the control rod and control sleeves

Insert control rod with play-compensating spring in pump housing. Screw in locating screw and tighten to 5...6 Nm.

Bring gear segments of control rod into center position.

Insert ring gear of one control sleeve into control rod so that the clamping jaws of the ring gear align with the locating pin of the pump barrel (see picture).

**D9**

Assembling the Injection Pump

PE(S)..A.., 0 410 ..



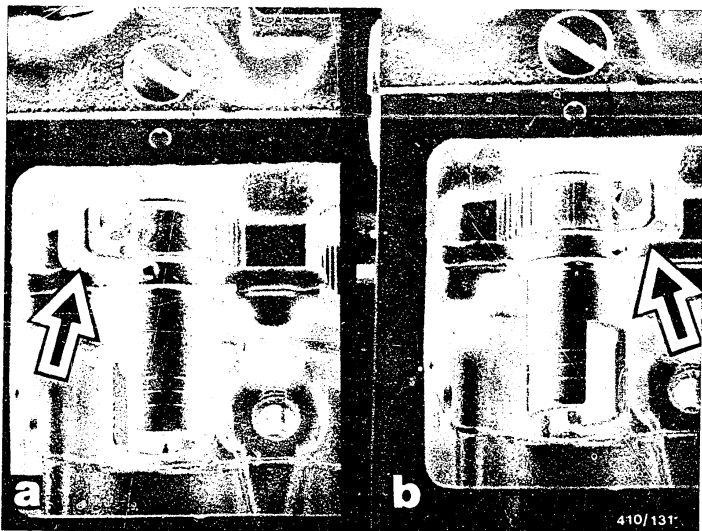

Move control rod all the way in one direction and then in the other and check whether ring gear clamping jaw is at the same distance from the housing collar (see picture, arrows) when deflected to left and right.

If the distance varies, bring control rod into center position and re-insert control sleeve.

**D10**

Assembling the Injection Pump

PE(S)..A., 0 410 ..



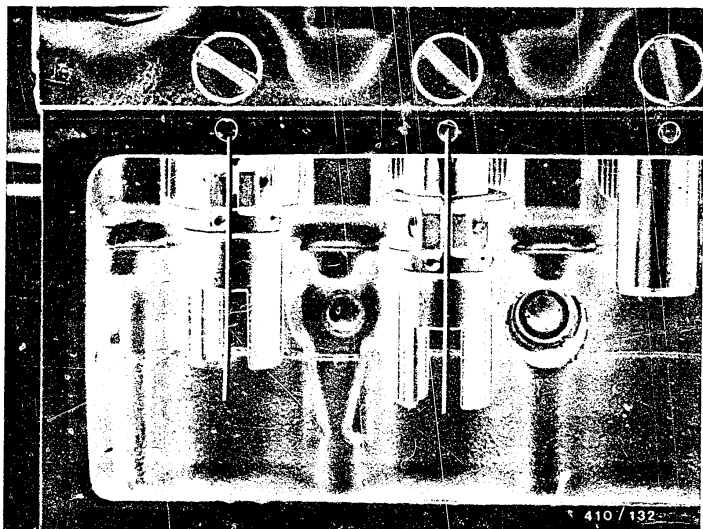

Bring the already inserted control sleeve into alignment with pump barrel locating pin (see picture).

Insert the remaining control sleeves in the same position.

Then check all ring gears for identical distance from housing collar when moved all the way to left and right.

**D11**

Assembling the Injection Pump

PE(S)..A.., 0 410 ..



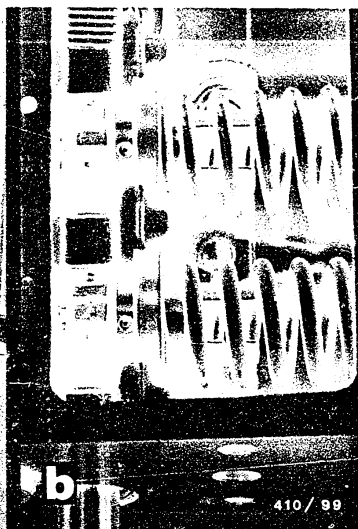
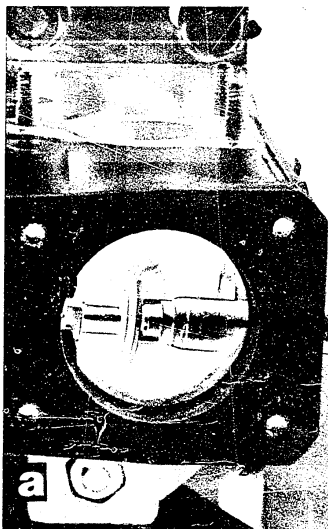

#### 11.4 Installing the pump plungers and roller tappets

Install upper spring seat and plunger spring (picture b).

Wet pump plunger with calibrating oil and insert in pump barrel with plunger pliers KDEP 2915 and lower spring seat (see picture a).

Check pump plunger for freedom of movement.

#### Note:

The notched mark on the plunger control arm must point up toward the spring chamber closing cover when inserting.



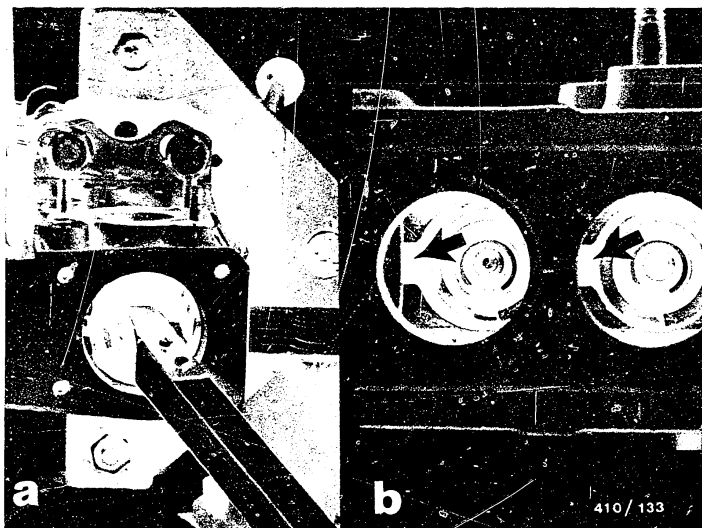

Introduce roller tappet with tappet holder KDEP 2941 into camshaft chamber (see picture a).

Bring sliding piece of roller tappet into alignment with groove in roller tappet guide (see picture b - arrows).

Using pressure-piece, press roller tappet against plunger spring and fix in uppermost position with tappet holder KDEP 2912 or 2995.

Note:

In case of pump housing of series S-3000, insert roller tappets with prestroke adjusting plates.

**D13**

Assembling the Injection Pump

PE(S)..A.., 0 410 ..



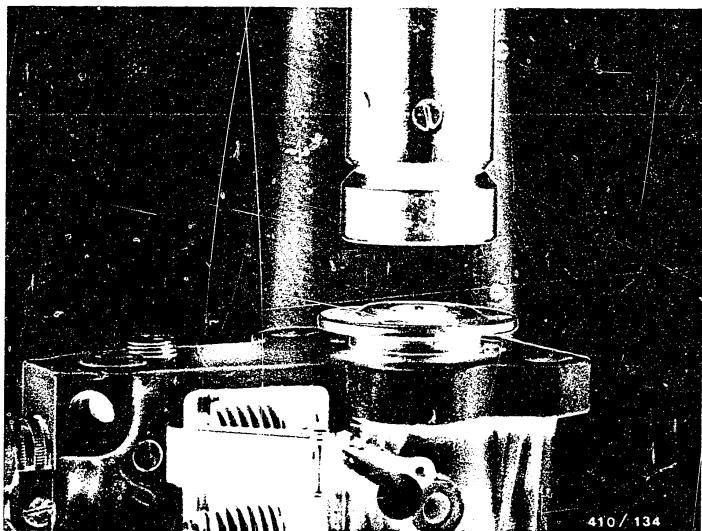

### 11.5 Installing the camshaft

Unscrew housing from clamping support.

Press drive end shield with new flat flange gasket into housing and tighten fastening screws to 7...9 Nm (M6) or 11...16 Nm (M8).

Re-clamp housing in clamping support and tilt.

**D14**

Assembling the Injection Pump  
PE(S)..A.., 0 410 ..



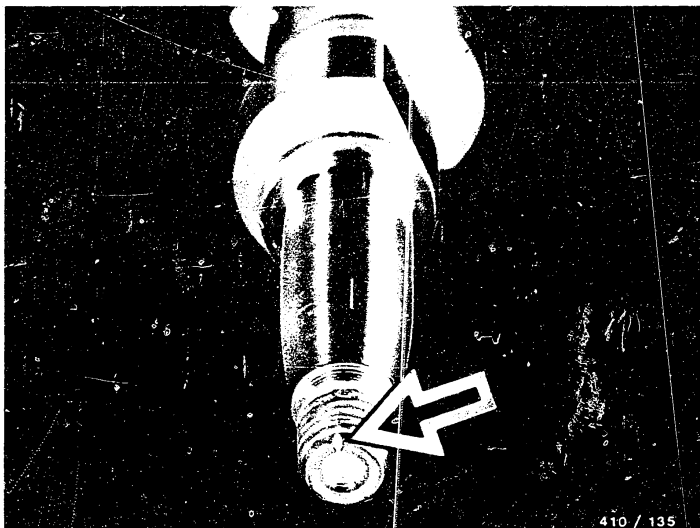

Before installing the camshaft, pay attention to the notched mark which is only on one end face of the two threaded shaft ends (see picture, arrow).

The installation position of the mark determines the correct cam sequence and is shown by the mounting number of the injection pump.

Note:

In the case of different cone diameters, the larger diameter always points to the drive end.

**D15**

Assembling the Injection Pump  
PE(S)..A., 0 410 ..



## Explanation of Mounting Numbers

Supply Pump (mounting side and number)														Governor	Timing device on pump side	Plunger helix	
without		Mounted on: Pump Side 3		Pump Side 4		Pump Sides 3 and 4				on pump side (1)	lower	upper					
1	2	1 piece	2 pieces	1 piece	2 pieces	1 piece	2 pieces	1	2				1			2	
100	200	300	400	500	600	700	800	900	1000					-	-		
101	201	301	401	501	601	701	801	901	1001					-	1		
102	202	302	402	502	602									-	2	left-handed	right-handed
110	210	310	410	510	610									1	-		
112	212	312	412	512	612									1	2		
120	220	320	420	520	620	720	820	920	1020	1320		1520	2	-			
121	221	321	421	521	621	721	821	921	1021				2	1	right-handed	left-handed	

Example: 421

Injection pump with shaft position 2 and one supply pump on pump side 3, governor on pump side 2 and timing device on pump side 1.

In 2-cylinder injection pumps of size A, the first digit of the mounting number signifies the angular cam spacing.

3../. = 90° or 270° in shaft position 1;

4../. = 180° in shaft position 2.

The mounting number may be followed by a code number indicating the mounting provisions for a supply pump, e.g.:

- ../3 = with mounting opening for supply pump, closed by cover (without supply pump).
- ../4 = with 2 mounting openings, left-hand with supply pump, right-hand closed by cover.
- ../5 = with 2 mounting openings, left-hand closed by cover, right-hand with supply pump.
- ../6 = with 2 mounting openings, both closed by covers (without supply pump).
- ../7 = with 2 mounting openings on both side 3 and side 4, right-hand mounting openings closed by covers.

1) In the case of mounting numbers which begin with an uneven digit (300, 500, 700 etc.) with governor position 2, the entire injection-pump assembly is turned through 180°.

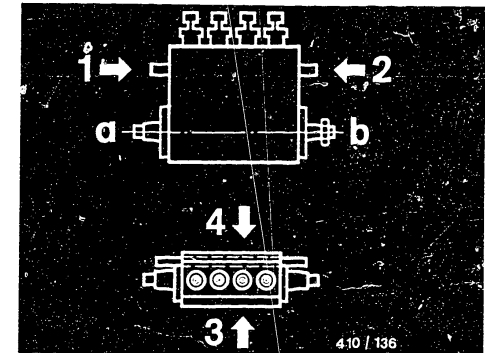

- 3,4 = For pump size A, if cover at front and control rod at rear
- a = shaft position 1 (notch on shaft end here)
- b = shaft position 2 (notch on shaft end here)

**D16**

Assembling the Injection Pump  
PE(S)..A.., 0 410 ..



**D17**

Assembling the Injection Pump  
PE(S)..A.., 0 410 ..





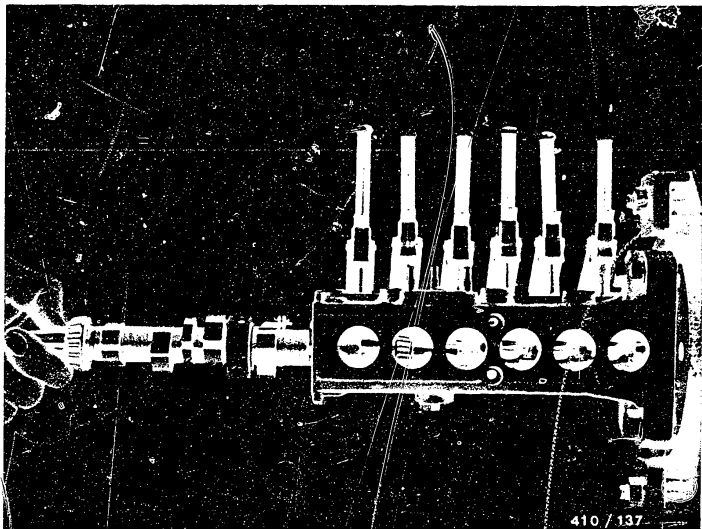

Introduce camshaft with intermediate bearing into camshaft chamber.

Tighten intermediate bearing fastening screws to 3.5 ... 5.5 Nm.

Note:

To prevent damage to the radial-lip-type oil seal when installing the camshaft, use a mounting sleeve to suit the cone diameter.

17 mm cone, mounting sleeve KDEP 2874

20 mm cone, mounting sleeve KDEP 2876

25 mm cone, mounting sleeve KDEP 2925

6/8 cyl. injection pumps S2000/3000 have 1 intermediate bearing.

10/12 cyl. injection pumps S2000/3000 have 2 intermediate bearings.

**D18**

Assembling the Injection Pump

PE(S)..A.., 0 410 ..



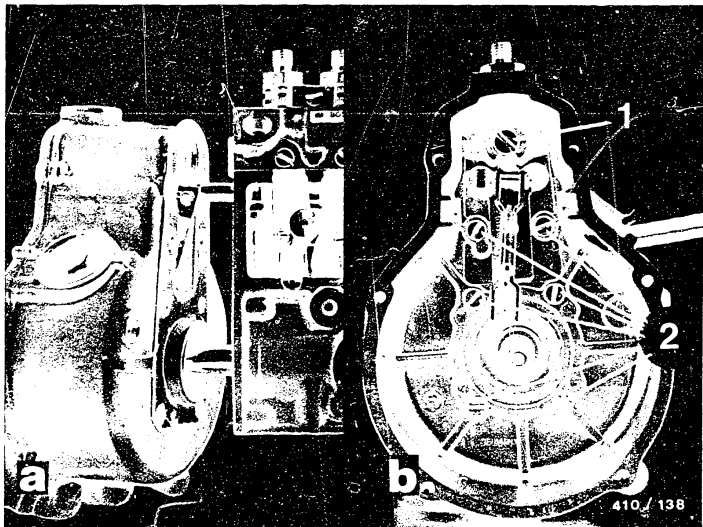

Position pump housing vertically.

Mount governor housing with new seal (see picture a).

Tighten governor housing fastening screws to the appropriate tightening torque (see picture b).

1 = flat head screw M8	13 ... 18 Nm
hexagon screw M8	18 ... 20 Nm
fillister-head screw M8	15 ... 18 Nm
2 = Fastening screws M6	6 ... 8 Nm

**D19**

Assembling the Injection Pump  
PE(S)..A., 0 410 ..



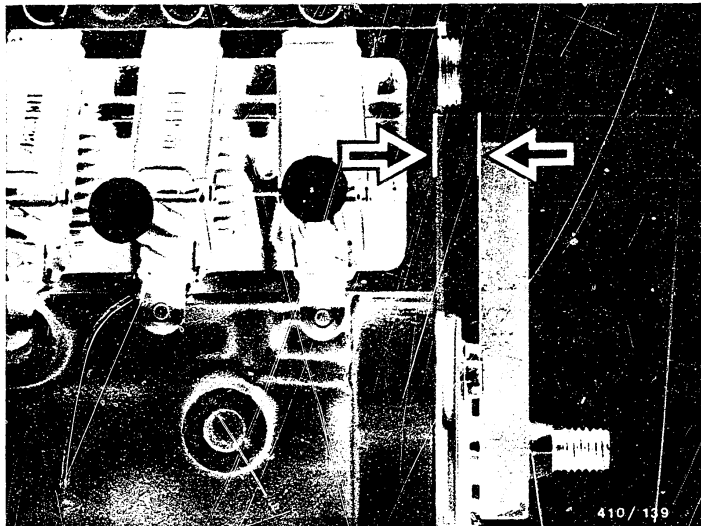

### 11.6 Checking and adjusting the camshaft projection and longitudinal play

To do this, unscrew end-flange-mounted injection pumps from clamping flange.

Slide measuring rule KDEP 2899 onto camshaft cone.

Using caliper gauge, measure distance from pump end face (see picture, arrows) and note down.

Specification: 9.3 ... 10.3 mm

Specification: (special version): 13.3 ... 14.3 mm

The projection dimension is adjusted by means of shims under the camshaft bearing.

#### Note:

The same shims are also used for adjusting the axial play of the camshaft.



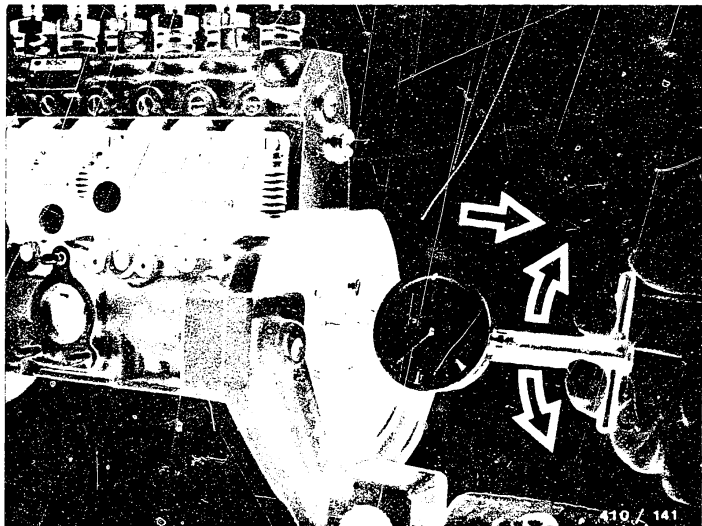

### Checking the camshaft axial play

Screw axial play measuring device (to suit cone diameter of camshaft) onto the drive end (see picture).

Insert dial indicator in mounting hole provided and preload by 1 mm.

#### Note:

Measuring device: KDEP 2890 for 17 mm cone  
KDEP 2927 for 20 mm cone  
KDEP 2967 for 25 mm cone

Employing short, fast rotary motions (approx. 45°), pull camshaft axially with measuring device.

**D21**

Assembling the Injection Pump  
PE(S)..A.., 0 410 ..



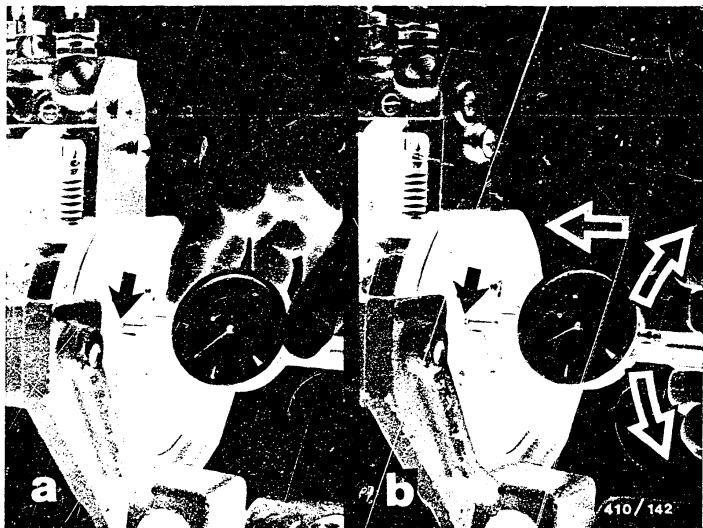

Release measuring device. Set dial indicator to "0"  
(see picture a).

Then, employing the same rotary motion, press axially on  
the camshaft and release at precisely the same point at  
which dial indicator was set to "0" (see white arrows,  
pictures a and b).

Read off axial play on dial indicator.

Specification:

Deep-groove ball bearing 0.03 ... 0.13 mm

Tapered-roller bearing 0.02 ... 0.06 mm

**D22**

Assembling the Injection Pump  
PE(S)..A., 0 410 ..



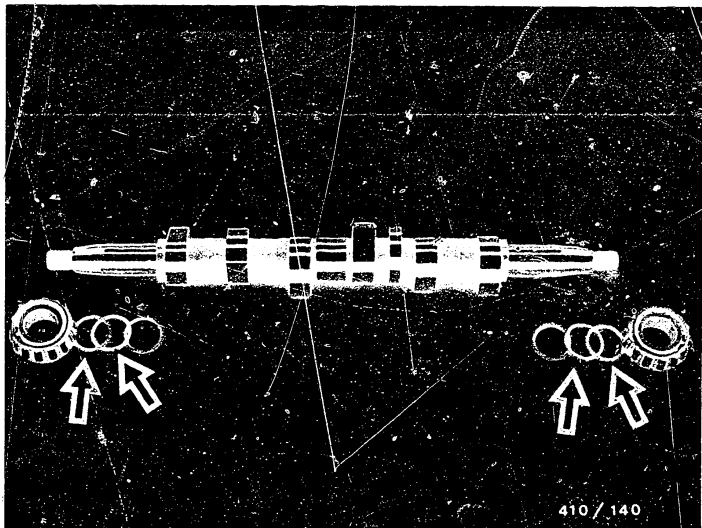

If the measured values for the projection dimension and the axial play are not within tolerance, remove camshaft, force off camshaft bearings and adjust projection dimension and/or axial play by changing the shims (see picture, arrows).

Check projection dimension and axial play again.

**D23**

Assembling the Injection Pump  
PE(S)..A.., 0 410 ..



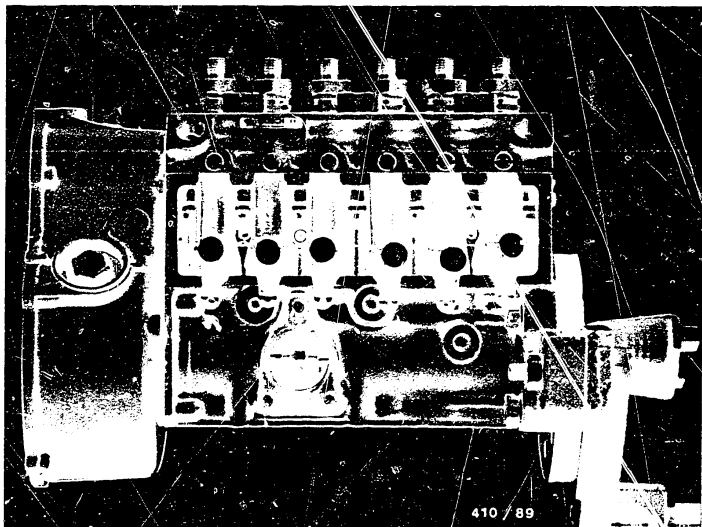

Mount drive coupling to suit cone diameter of camshaft and tighten (hold with holding wrench KDEP 2906).

Turn camshaft and, with the respective cam at TDC, remove tappet holder.

Check control rod for freedom of movement.

Tilt injection pump (90°).

Note:

If the control rod is stiff, check vertical play of control sleeves.



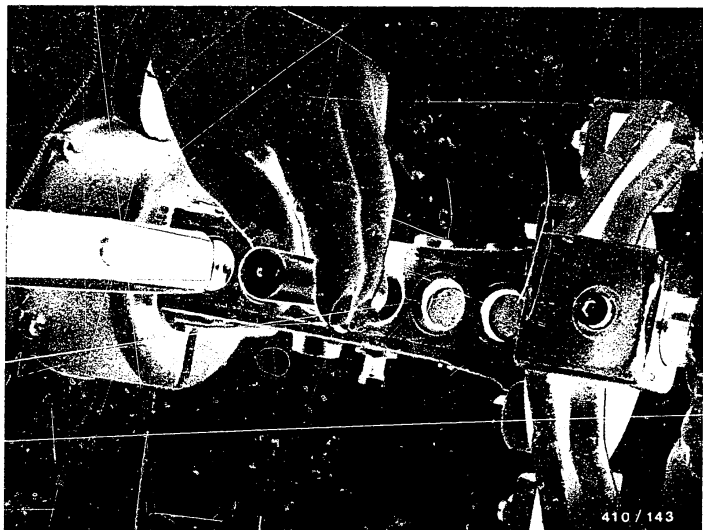

### 11.7 Inserting the base closing covers

Knock in base closing covers flush with mandrel  
KDEP 1585.

**E1**

Assembling the Injection Pump  
PE(S)..A., 0 410 ..





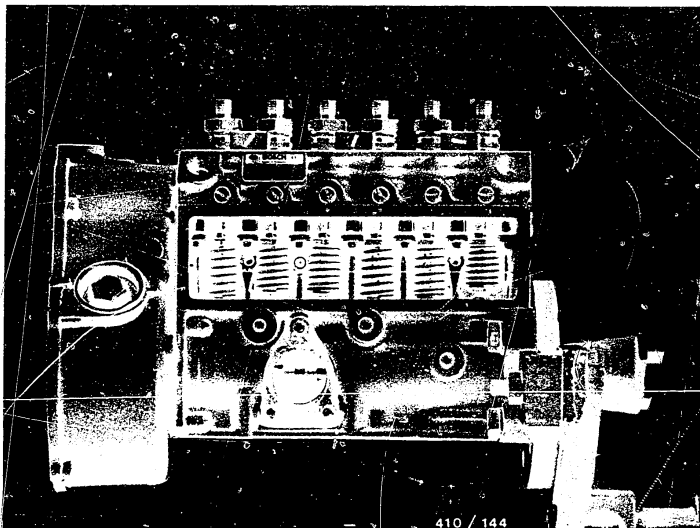

Assemble governor in accordance with respective repair instructions.

Do not mount fuel supply pump, spring-chamber closing covers or control-rod stop until after the pump has been set on the pump test bench.

Remove injection pump from clamping support.

Note:

If the injection pump is not to be set immediately, mount the above-mentioned parts.

**E2**

Assembling the Injection Pump  
PE(S)..A.., 0 410 ..



### 11.8 Leak test on camshaft chamber, spring chamber and governor chamber

Finish off the assembly of the injection pump. Compressed air is required for the leak test. Introduce into the pump camshaft chamber at a suitable place (e.g. oil inspection bore).

Immerse injection pump vertically into oil bath.

Test duration and test pressure:

- 3 minutes at 1.5 bar, then  
1 minute at 0.5 bar

Visually examine whether there are any leaks at joints, screw connections, seal rings and end covers on housing and cover.

No air bubbles may be visible.

To prevent possible skin rashes, grease hands beforehand with protective skin cream and wash with soap and water after the test is completed.

**E3**

Assembling the Injection Pump  
PE(S)..A.., 0 410 ..



## Table of Contents

<u>Section</u>	<u>Coordinates</u>
Structure of microfiche	A 1
1. Special features	A 2
2. Test specifications, tightening torques	A 2
3. General Information	A 8
3.1 Lubrication instructions	A 8
3.2 Cleaning the components	A 8
3.3 Skin protection	A 8
3.4 Safety regulations	A 9
4. Tools, fixtures, lubricants	A 10
5. Exploded view	A 15
6. Clamping the injection pump	B 1
7. Dismantling the injection pump	B 3
8. Cleaning the components	B 21
9. Checking the components	B 22
10. Repairing the injection pump	C 9
10.1 Replacing the bearing outer races	C 9
10.2 Replacing the radial seals	C 11
10.3 Replacing the camshaft bearings	C 12
10.4 Reworking the plunger-and-barrel assembly seats	C 14
10.5 Replacing the control sleeve ring gear	C 15
10.6 Replacing the control rod guide bushing	C 16
10.7 Replacing the screw plug at the unused fuel inlet	C 19
11. Assembling the injection pump	C 20
11.1 Installing the pump barrels and delivery valves	C 21



## Table of Contents (continued)

<u>Section</u>	<u>Coordinates</u>
11.2 Leak test on suction gallery	D 2
11.3 Mounting the control rod and control sleeves	D 9
11.4 Installing the pump plungers and roller tappets	D 12
11.5 Installing the camshaft	D 14
11.6 Checking and adjusting the projection and longitudinal play	D 20
11.7 Inserting the base closing covers	E 1
11.8 Leak test on camshaft chamber, spring chamber, governor chamber	E 3

© 1985 Robert Bosch GmbH  
Automotive Equipment - After-Sales Service  
Department for Technical Publications KH/VDT  
Postfach 50, D-7000 Stuttgart 1.

Published by: After-Sales Service Department for  
Training and Technology (KH/VSK). Press date: 2.85

Please direct questions and comments concerning the  
contents to our authorized representative in your  
country.

This publication is intended only for the BOSCH After-  
Sales Service Organization, and may not be passed on to  
third parties without our consent.

Microfilmed in the Federal Republic of Germany  
Microphotographié en République Fédérale d'Allemagne.

**N24**

Table of Contents/Impressum  
PE(S)..A.., 0 410 ..

